

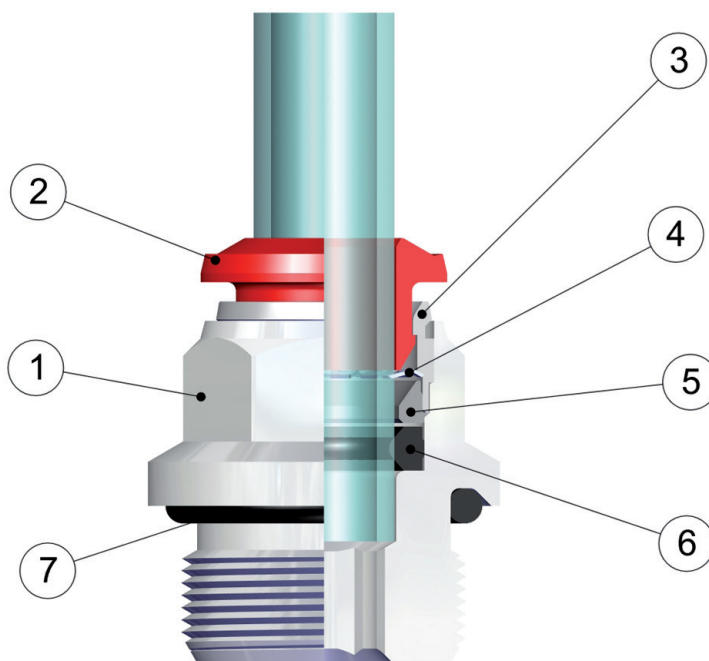

Серия 50000

ЦАНГОВЫЕ ФИТИНГИ
PUSH-IN FITTINGS

Технические характеристики / Technical Characteristics



Части и материалы / Component Parts and Materials

1 Никелированный латунный корпус	1 Nickel-plated brass Body
2 Демонтажное кольцо из ацетальной смолы	2 Acetalic resin Collet
3 Никелированная латунная фиксирующая втулка	3 Nickel-plated brass Capsule
4 Цанга из нержавеющей стали	4 Steel aisi 301 Clamping washer
5 Технополимерное опорное кольцо	5 Technopolymeric Safety ring
6 Уплотнение из NBR	6 Nbr Lip seal
7 Уплотнительное кольцо из NBR	7 Nbr Thread packing

Давление / Pressures

Минимальное давление / Minimum pressure: -0.99 bar (-0.099 MPa)
 Максимальное давление / Maximum pressure: 15 bar (1.5 MPa)

Температура / Temperatures

Минимальная температура / Minimum temperature: -20 °C
 Максимальная температура / Maximum temperature: +80 °C

Резьба / Threads

Коническая резьба "short" / "Short" Tapered thread.
 Коническая резьба ISO 7.1, BS 21, DIN 2999 / Tapered gas in conformity with ISO7.1, BS 21, DIN 2999.
 Цилиндрическая резьба ISO 228 Classe A / Parallel gas in conformity with ISO 228 Class A.
 Метрическая резьба ISO R/262 / Metric in conformity with ISO R/262.

Соединяемые трубки / Connection Tubes

Пластиковые трубки:
 PA6, PA11, PA12, Полиэтилен, *Полиуретан, PTFE, FEP.
 *Для полиуретановых труб требуется минимальная твердость 98 shore.
 Plastic tubes:
 PA6, PA11, PA12, Polyethylene, *Polyurethane, PTFE, FEP.
 *For Polyurethane hoses it is required a minimum hardness of 98 shore.

Рабочая среда / Fluids

Сжатый воздух / Compressed air.
 Вакуум / Vacuum

Резьбы / Threads

Коническая резьба "short" была разработана что бы получить следующие преимущества:

- уменьшить общую длину
- меньший размер под гаечный ключ в сочетании с цилиндрической резьбой
- возможность соединения с разными внутренними резьбами как с конической так и цилиндрической

The "short" taper thread has been designed to offer the following advantages to the users:

- reduced overall length;
- smaller hex dimensions compared to the parallel threads;
- to allow the assembly with different female threads both taper as well as parallel;

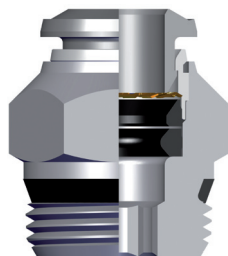

NPT
NPTF

Коническая
Tapered

ISO 7
BSPP

Цилиндрическая
Parallell

ISO 7
BSPT
PT

Коническая
Tapered

ISO 228
BSP
PF

Цилиндрическая
Parallell

Обеспечивает хорошую герметичность с необработанными поверхностями, без фасок и с фасками разных видов и разных размеров.

To ensure the right tightening also with surfaces not perfectly flat, without spot-facing, concave convex and with different kinds of chamfers or radius.

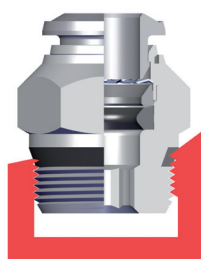

Скошенный
Inclined

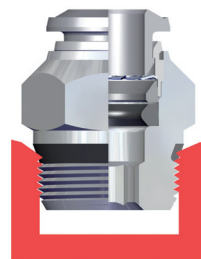

Внутренняя фаска
Concave

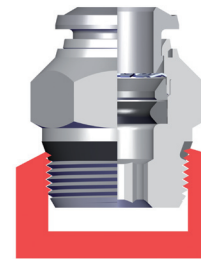

Внешняя фаска
Convex

Таблица крутящих моментов / Torque specifications

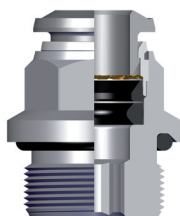

COPIE DI SERRAGGIO PER FILETTATURE MASCHIO ISO-228 CON OR
TORQUE TO MALE THREADS ISO-228 WITH OR

MISURA MEASURE	COPPIA CONSIGLIATA Nm RECOMMENDED TORQUE Nm	COPPIA DI ROTTURA Nm BREAKING TORQUE Nm
M5	0,08	0,32
1/8	3	8
1/4	9	30
3/8	10	60
1/2	12	50

I VALORI DI ROTTURA POSSONO VARIARE IN BASE ALL'ARTICOLO
BREAKING VALUES MAY VARY ACCORDING TO THE ITEM

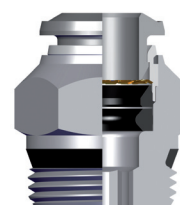

COPIE DI SERRAGGIO PER FILETTATURE MASCHIO "SHORT"
TORQUE TO MALE THREADS "SHORT"

MISURA MEASURE	COPPIA MINIMA CONSIGLIATA Nm RECOMMENDED MINIMUM TORQUE Nm	COPPIA MASSIMA CONSIGLIATA Nm RECOMMENDED MAX TORQUE Nm
1/8	5	7
1/4	5	7
3/8	5	7
1/2	5	7

I VALORI DI ROTTURA POSSONO VARIARE IN BASE ALL'ARTICOLO
BREAKING VALUES MAY VARY ACCORDING TO THE ITEM

Все резьбы этой серии (также M5) укомплектованы уплотнениями, которые уже установлены на фитинги, что позволяет сократить время монтажа.

All of threads from this range (also the M5), have been equipped with tightening parts which allow the direct assembly of the fittings, reducing the installation time.

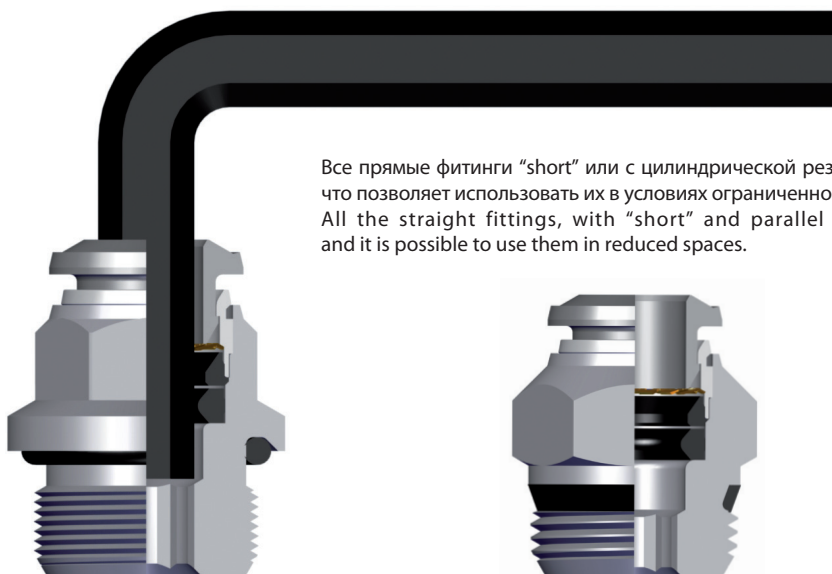
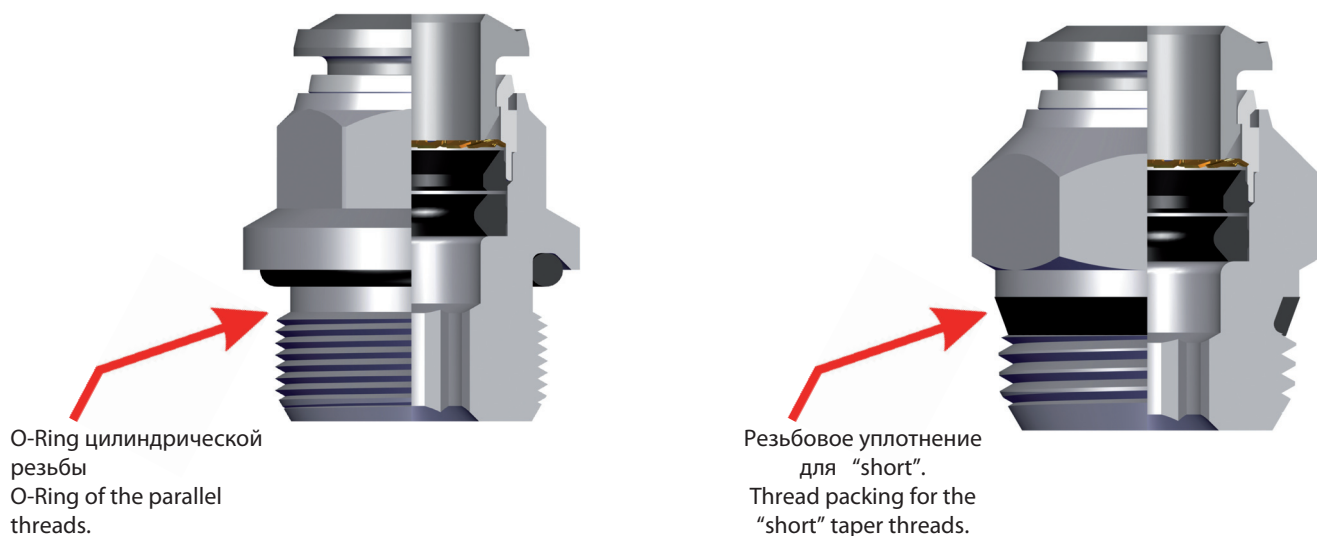

Все прямые фитинги "short" или с цилиндрической резьбой могут монтироваться с помощью гаечного ключа, что позволяет использовать их в условиях ограниченного пространства.

All the straight fittings, with "short" and parallel threads can be assembled also with Allen wrench and it is possible to use them in reduced spaces.

Цанга / Clamping washer

Цанга сделана из нержавеющей стали, и обеспечивает отличный зажим трубы из любого материала без повреждения поверхности.

The washer is made in stainless steel ensures the perfect tube clamping with every Kinds of materials without damage the surface.

Соединение между трубкой и фитингом обеспечивает полную герметичности даже при ударах и вибрации

The connection between the tube and the fitting ensure a total tightness even in severe conditions such as impact and vibrations.

Специальная форма уплотнения обеспечивает герметичность даже в вакууме.

The particular geometric shape of the seal ensure the perfect tightness even with vacuum.

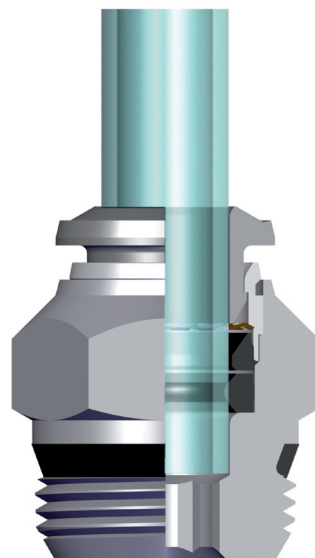

50000

ПРЯМОЙ АДАПТОР "ПАПА" (SHORT) - STRAIGHT MALE ADAPTOR (SHORT)

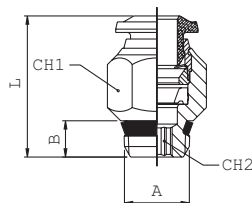

Код Code	Трубка Tube	A	B	L	CH1	CH2	Упак. Pack.
500000001	4	1/8	5.5	18	11	3	10
500000013	4	1/4	7	19	14	3	10
500000011	5	1/8	5.5	20	11	4	10
500000012	5	1/4	7	20	14	4	10
500000002	6	1/8	5.5	21.5	13	4	10
500000003	6	1/4	7	21	14	4	10
500000014	6	3/8	7.5	23	17	4	10
500000015	6	1/2	9	23.5	21	4	10
500000004	8	1/8	5.5	24.5	14	5	10
500000005	8	1/4	7	22	14	6	10
500000006	8	3/8	7.5	23	17	6	10
500000016	8	1/2	9	23.5	21	6	10
500000007	10	1/4	7	28	17	7	10
500000008	10	3/8	7.5	25.5	17	8	10
500000017	10	1/2	9	26	21	8	10
500000009	12	1/4	7	31.5	20	7	10
500000010	12	3/8	7.5	29.5	20	9	10
500000018	12	1/2	9	31.5	21	10	10
500000019	14	3/8	7.5	32.5	21	9	10
500000020	14	1/2	9	31.5	21	10	10

50010

ПРЯМОЙ АДАПТОР "ПАПА" (SHORT) СО ВСТРОЕННЫМ ШЕСТИГАННИКОМ - STRAIGHT MALE ADAPTOR (SHORT) WITH EXAGON EMBEDDED

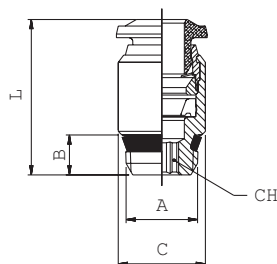

Код Code	Трубка Tube	A	B	C	L	CH	Упак. Pack.
5001000083	M5	4	8	19	2.5		10
5001000014	M5	4	9.5	19.5	2.5		10
5001000024	1/8	5.5	11	18	3		10
5001000094	M7x1	5	10	21	2.5		10
5001000076	M5	4	12	24.5	2.5		10
5001000036	1/8	5.5	12	21.5	4		10
5001000046	1/4	7	14	21	4		10
5001000058	1/8	5.5	14	25	5		10
5001000068	1/4	7	14	22.5	6		10

50020

ПРЯМОЙ АДАПТОР "ПАПА" (цилиндрическая) - STRAIGHT MALE ADAPTOR (PARALLEL)

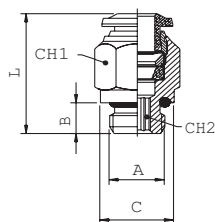
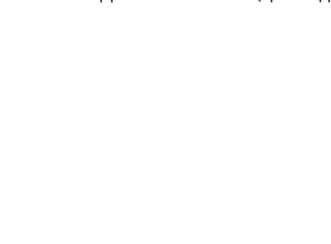

Код Code	Трубка Tube	A	B	C	L	CH1	CH2	Conf. Pack.
5002000021	3	M5	4	8	19	8	2	10
5002000034	4	M3	3	10	21	-	8	10
5002000001	4	M5	4	8	21	10	2	10
5002000002	4	1/8	6	13	20	10	3	10
5002000022	4	1/4	8	16	19.5	16	3	10
5002000018	5	M5	4	8	23.5	12	2	10
5002000019	5	1/8	6	13	22	12	4	10
5002000036	5	1/4	8	16	22	12	4	10
5002000020	6	M5	4	10	24.5	13	2	10
5002000003	6	1/8	6	13	23.5	13	4	10
5002000004	6	1/4	8	16	23.5	13	4	10
5002000027	6	3/8	9	20	25	13	4	10
5002000028	6	1/2	10	25	27	13	4	10
5002000005	8	1/8	6	13	25	14	5	10
5002000006	8	1/4	8	16	23	14	6	10
5002000007	8	3/8	9	20	24	14	6	10
5002000029	8	1/2	10	25	26.5	14	6	10
5002000008	10	1/4	8	16	30.5	17	6	10
5002000009	10	3/8	9	20	27.5	17	8	10
5002000031	10	1/2	10	25	27	17	8	10
5002000032	12	1/4	8	16	34.5	20	6	10
5002000011	12	3/8	9	20	34	20	8	10
5002000023	12	1/2	10	25	31	22	10	10
5002000024	14	3/8	9	20	35	21	10	10
5002000025	14	1/2	10	25	32	22	10	10
5002000012	6	M12x1	8	15	23.5	13	4	10
5002000013	6	M12x1.25	8	15	23.5	13	4	10
5002000014	6	M12x1.5	8	15	23.5	13	4	10
5002000017	8	M12x1.5	8	15	27.5	14	6	10

50030

ПРЯМОЕ СОЕДИНЕНИЕ С ВНУТРЕННЕЙ РЕЗЬБОЙ - STRAIGHT FEMALE ADAPTOR

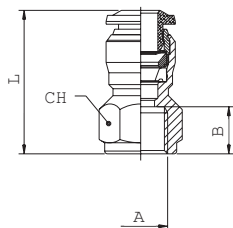

Код Code	Трубка Tube	A	B	L	CH	Упак. Pack.
500300007	3	M5	5.5	18.5	9	10
500300008	4	M5	5.5	21	11	10
500300001	4	1/8	8.5	24	13	10
500300009	4	1/4	11	27.5	16	10
500300006	5	1/8	8.5	26.5	13	10
500300002	6	1/8	8.5	26	13	10
500300003	6	1/4	11	29.5	16	10
500300004	8	1/8	8.5	27	15	10
500300005	8	1/4	11	29.5	17	10
500300010	8	3/8	12	32	19	10
500300011	10	1/4	11	32	18	10
500300012	10	3/8	12	33.5	19	10
500300013	10	1/2	15	39	24	10
500300014	12	3/8	12	36	21	10
500300015	12	1/2	15	41	24	10

50040

ПРЯМОЕ СОЕДИНЕНИЕ - STRAIGHT CONNECTOR

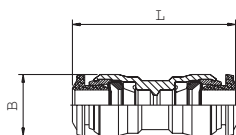

Код Code	Трубка Tube	L	B	Упак. Pack.	
500400009	3	26	8.5	10	
500400001	4	30.5	10.5	10	
500400008	5	33	11.5	10	
500400002	6	4	32	12.5	10
500400003	6	34	12.5	10	
500400004	8	6	35	14.5	10
500400005	8	36	14.5	10	
500400011	10	8	40.5	17.5	10
500400006	10	42	17.5	10	
500400012	12	10	45.5	20.5	10
500400007	12	47	20.5	10	
500400010	14	49	21.5	10	

50050

ПЕРЕБОРОЧНОЕ СОЕДИНЕНИЕ - BULKHEAD CONNECTOR

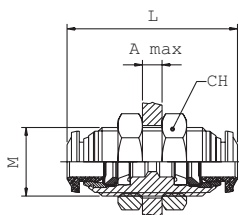

Код Code	Трубка Tube	M	L	CH	A max	Упак. Pack.
500500007	3	M10x1	26	14	5	10
500500001	4	M12x1	31.5	17	7	10
500500006	5	M14x1	33	17	7	10
500500002	6	M14x1	35	17	9.5	10
500500003	8	M16x1	37	19	10.5	10
500500004	10	M20x1	43	24	12.5	10
500500005	12	M22x1	48	26	16.5	10

50100

УГЛОВОЙ АДАПТОР НАРУЖНЯЯ РЕЗЬБА (КОНИЧЕСКАЯ) - ELBOW MALE ADAPTOR (TAPER)

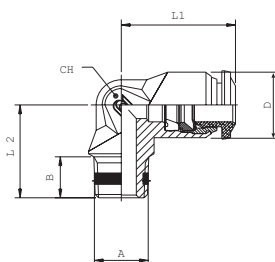

Код Code	Трубка Tube	A	B	L1	L2	CH	D	Упак. Pack.
501000001	4	M5	5	17	15	9	10	10
501000002	4	1/8	7.5	17	15.5	9	10	10
501000010	5	M5	5	20	17	11	12.5	10
501000011	5	1/8	7.5	20	17.5	11	12.5	10
501000003	6	1/8	7.5	21	17.5	11	12.5	10
501000012	6	1/4	11	21	21.5	11	12.5	10
501000004	8	1/8	7.5	22.5	19	13	14	10
501000005	8	1/4	11	22.5	21.5	13	14	10
501000006	10	1/4	11	26.5	24.5	16	17	10
501000007	10	3/8	11.5	26.5	24	16	17	10
501000008	12	1/4	11	30.5	28	19	21.5	10
501000009	12	3/8	11.5	30.5	28	19	21.5	10

50106

УГЛОВОЕ ПОВОРОТНОЕ СОЕДИНЕНИЕ ВНУТРЕННЯЯ РЕЗЬБА - ORIENTING ELBOW FEMALE ADAPTOR

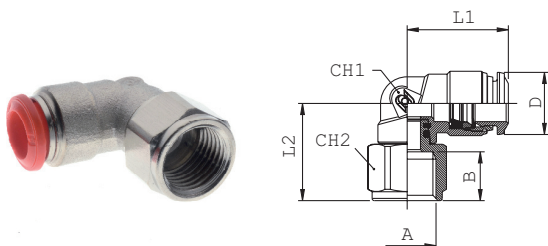

Код Code	Трубка Tube	A	B	L1	L2	CH1	CH2	D	Упак. Pack.
501060001	4	- 1/8	8.5	18	19	9	13	10	10
501060002	4	- 1/4	11	18	21.5	9	16	10	10
501060003	6	- 1/8	8.5	21	20.5	11	13	12.5	10
501060004	6	- 1/4	11	21	23	11	16	12.5	10
501060005	8	- 1/8	8.5	22.5	22	12	13	14.5	10
501060006	8	- 1/4	11	22.5	24.5	12	16	14.5	10

50111

УГЛОВОЕ ПОВОРОТНОЕ СОЕДИНЕНИЕ НАРУЖНЯЯ РЕЗЬБА (SHORT) - ORIENTING ELBOW MALE ADAPTOR (SHORT)

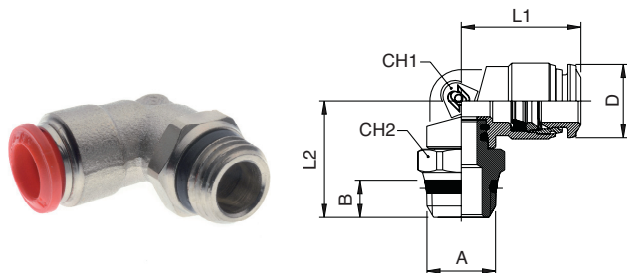

Код Code	Трубка Tube	A	B	L1	L2	CH	CH2	D	Упак. Pack.
501110001	4	1/8	5.5	18	19.5	9	13	10	10
501110002	4	1/4	7	18	21	9	15	10	10
501110003	5	1/8	5.5	20	21.5	11	13	12.5	10
501110004	6	1/8	5.5	21	21.5	11	13	12.5	10
501110005	6	1/4	7	21	23	11	15	12.5	10
501110006	8	1/8	5.5	22.5	24	12	13	14.5	10
501110007	8	1/4	7	22.5	24	12	15	14.5	10
501110008	8	3/8	7.5	22.5	24.5	12	17	14.5	10
501110009	8	1/2	9	22.5	27	12	21	14.5	10
501110010	10	1/4	7	26.5	26.5	14	16	17.5	10
501110011	10	3/8	7.5	26.5	24.5	14	17	17.5	10
501110012	10	1/2	9	26.5	27	14	21	17.5	10
501110013	12	3/8	7.5	31.5	26.5	16	20	21.5	10
501110014	12	1/2	9	31.5	29	16	21	21.5	10
501110015	14	3/8	7.5	31.5	27	16	20	21.5	10
501110016	14	1/2	9	31.5	29.5	16	21	21.5	10

50116

УГЛОВОЕ ПОВОРОТНОЕ СОЕДИНЕНИЕ НАРУЖНЯЯ РЕЗЬБА (ЦИЛИНДРИЧЕСКАЯ) - ORIENTING ELBOW MALE ADAPTOR (PARALLEL)

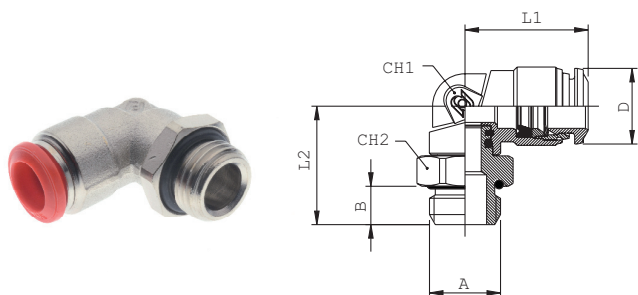

Codice Code	Tubo Tube	A	B	L1	L2	CH1	CH2	D	Conf. Pack.
501160001	3	M5	3.5	16.5	17.5	9	8	10	10
501160002	4	M5	3.5	18	17.5	9	8	10	10
501160003	4	1/8	5.5	18	18	9	13	10	10
501160004	4	1/4	7	18	18	9	16	10	10
501160005	5	M5	3.5	20	20	11	11	12.5	10
501160006	5	1/8	5.5	20	20	11	13	12.5	10
501160007	6	M5	3.5	21	20	11	11	12.5	10
501160008	6	1/8	5.5	21	20	11	13	12.5	10
501160009	6	1/4	7	21	21.5	11	16	12.5	10
501160010	8	1/8	5.5	22.5	22.5	12	13	14.5	10
501160011	8	1/4	7	22.5	23	12	16	14.5	10
501160012	8	3/8	8	22.5	25	12	20	14.5	25
501160013	8	1/2	9.5	22.5	26.5	12	25	14.5	10
501160014	10	1/4	7	26.5	25.5	14	16	17.5	10
501160015	10	3/8	8	26.5	25	14	20	17.5	10
501160016	10	1/2	9.5	26.5	26.5	14	25	17.5	10
501160025	12	1/4	8	31.5	27.5	16	20	21.5	10
501160017	12	3/8	8	31.5	27	16	20	21.5	10
501160018	12	1/2	9.5	31.5	28.5	16	25	21.5	10
501160019	14	3/8	8	31.5	27.5	16	20	21.5	10
501160020	14	1/2	9.5	31.5	29	16	25	21.5	10
501160021	6	M12x1	7.5	20	22	11	16	12.5	10
501160022	6	M12x1.25	7.5	20	22	11	16	12.5	10
501160023	6	M12x1.5	7.5	20	22	11	16	12.5	10
501160024	8	M12x1.5	7.5	22.5	23.5	12	16	14.5	10

50121

УГЛОВОЕ ПОВОРОТНОЕ СОЕДИНЕНИЕ НАРУЖНЯЯ РЕЗЬБА (SHORT) - EXTENDED ORIENTING ELBOW MALE ADAPTOR (SHORT)

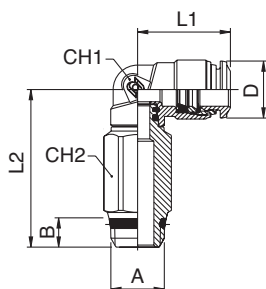
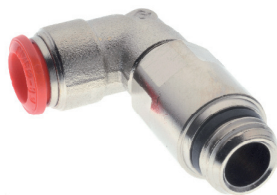

Код Code	Трубка Tube	A	B	L1	L2	CH1	CH2	D	Упак. Pack.
5012100001	4	1/8	5.5	18	31.5	9	12	10	10
5012100002	4	1/4	7	18	33	9	15	10	10
5012100003	5	1/8	5.5	20	36	11	12	12.5	10
5012100004	6	1/8	5.5	21	36	11	12	12.5	10
5012100005	6	1/4	7	21	37.5	11	15	12.5	10
5012100006	8	1/8	5.5	22.5	40.5	12	12	14.5	10
5012100007	8	1/4	7	22.5	40.5	12	15	14.5	10
5012100008	8	3/8	7.5	22.5	41	12	16	14.5	10
5012100009	10	1/4	7	26.5	46	14	15	17.5	10
5012100010	10	3/8	7.5	26.5	44	14	17	17.5	10

50126

УГЛОВОЕ ПОВОРОТНОЕ СОЕДИНЕНИЕ НАРУЖНЯЯ РЕЗЬБА (ЦИЛИНДРИЧЕСКАЯ) - EXTENDED ORIENTING ELBOW MALE ADAPTOR (PARALLEL)

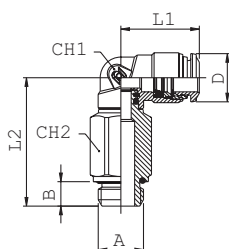

Код Code	Трубка Tube	A	B	L1	L2	CH1	CH2	D	Упак. Pack.
5012600001	4	1/8	5.5	18	30	9	12	10	10
5012600002	4	1/4	7	18	32	9	15	10	10
5012600003	5	1/8	5.5	20	34.5	11	12	12.5	10
5012600004	6	1/8	5.5	21	34.5	11	12	12.5	10
5012600005	6	1/4	7	21	36	11	15	12.5	10
5012600006	8	1/8	5	23	39	12	12	14.5	10
5012600007	8	1/4	7	22.5	39.5	12	15	14.5	10
5012600008	8	3/8	8	22.5	41.5	12	18	14.5	10
5012600009	10	1/4	7	26.5	45	14	16	17.5	10
5012600010	10	3/8	8	26.5	44.5	14	18	17.5	10

50130

УГЛОВОЕ СОЕДИНЕНИЕ - ELBOW CONNECTOR

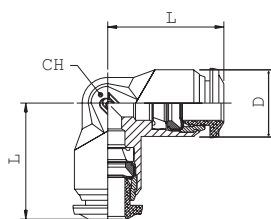

Код Code	Трубка Tube	L	CH	D	Упак. Pack.
5013000007	3	17	9	10	10
5013000001	4	17	9	10	10
5013000006	5	20	11	12.5	10
5013000002	6	21	11	12.5	10
5013000003	8	22.5	13	14	10
5013000004	10	26.5	16	17	10
5013000005	12	30.5	19	21.5	10
5013000008	14	32.5	19	21.5	10

50200

ТРОЙНИК Т-образный НАРУЖНЯЯ РЕЗЬБА (КОНИЧЕСКАЯ) - TEE MALE ADAPTOR (TAPER) - CENTRE LEG

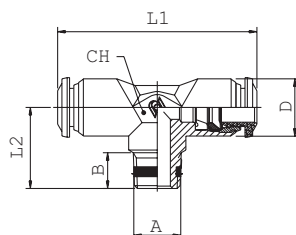

Код Code	Трубка Tube	A	B	L1	L2	CH	D	Упак. Pack.
5020000001	4 - M5	5	34	15	9	10	10	10
5020000002	4 - 1/8	7.5	34	15.5	9	10	10	10
5020000010	5 - 1/8	7.5	40	17.5	11	12.5	10	10
5020000003	6 - 1/8	7.5	42	17.5	11	12.5	10	10
5020000004	8 - 1/8	7.5	45	19	13	14	10	10
5020000005	8 - 1/4	11	45	21.5	13	14	10	10
5020000006	10 - 1/4	11	53	24.5	16	17	10	10
5020000007	10 - 3/8	11.5	53	24	16	17	10	10
5020000008	12 - 1/4	11	61	28	19	21.5	10	10
5020000009	12 - 3/8	11.5	61	28	19	21.5	10	10

50211

ТРОЙНИК ПОВОРОТНЫЙ Т-образный НАРУЖНЯЯ РЕЗЬБА (SHORT) - ORIENTING TEE MALE ADAPTOR (SHORT) - CENTRE LEG

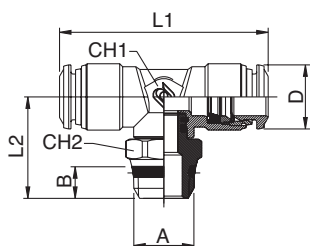

Код Code	Трубка Tube	A	B	L1	L2	CH1	CH2	D	Упак. Pack.
5021100001	4	1/8	5.5	34	20	9	13	10	10
5021100002	4	1/4	7	34	21.5	9	15	10	10
5021100003	5	1/8	5.5	40	22	11	13	12.5	10
5021100004	6	1/8	5.5	42	22	11	13	12.5	10
5021100005	6	1/4	7	42	23.5	11	15	12.5	10
5021100006	8	1/8	5.5	45	25.5	13	13	14.5	10
5021100007	8	1/4	7	45	25.5	13	15	14.5	10
5021100008	8	3/8	7.5	45	26	13	17	14.5	10
5021100009	8	1/2	9	45	28.5	13	21	14.5	10
5021100010	10	1/4	7	53	29	14	16	17.5	10
5021100011	10	3/8	7.5	53	27	14	17	17.5	10
5021100012	10	1/2	9	53	29.5	14	21	17.5	10
5021100013	12	3/8	7.5	62.6	29.5	16	20	21.5	10
5021100014	12	1/2	9	62.6	32	16	21	21.5	10
5021100015	14	3/8	7.5	62.6	29.5	16	20	21.5	10
5021100016	14	1/2	9	62.6	32	16	21	21.5	10

50216

ТРОЙНИК ПОВОРОТНЫЙ Т-образный НАРУЖНЯЯ РЕЗЬБА (ЦИЛИНДРИЧЕСКАЯ) - ORIENTING TEE MALE ADAPTOR (PARALLEL) - CENTRE LEG

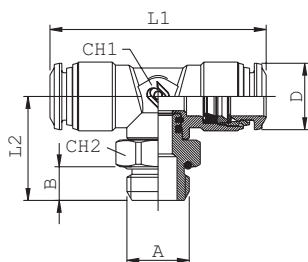
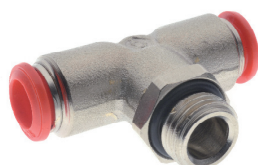

Код Code	Трубка Tube	A	B	L1	L2	CH1	CH2	D	Упак. Pack.
5021600001	3	M5	3.5	33	17	9	8	10	10
5021600002	4	M5	3.5	34	18	9	8	10	10
5021600003	4	1/8	5.5	34	18.5	9	13	10	10
5021600004	4	1/4	7	34	20	9	16	10	10
5021600005	5	M5	3.5	40	20.5	11	11	12.5	10
5021600006	5	1/8	5.5	40	20.5	11	13	12.5	10
5021600007	6	M5	3.5	42	20.5	11	11	12.5	10
5021600008	6	1/8	5.5	42	20.5	11	13	12.5	10
5021600009	6	1/4	7	42	22	11	16	12.5	10
5021600010	8	1/8	5.5	45	23.5	13	13	14.5	10
5021600011	8	1/4	7	45	24	13	16	14.5	10
5021600012	8	3/8	8	45	26	13	20	14.5	10
5021600013	8	1/2	9.5	45	27.5	13	25	14.5	10
5021600014	10	1/4	7	53	27.5	14	16	17.5	10
5021600015	10	3/8	8	53	27	14	20	17.5	10
5021600016	10	1/2	9.5	53	28.5	14	25	17.5	10
5021600017	12	3/8	8	62.5	29.5	16	20	21.5	10
5021600018	12	1/2	9.5	62.5	31	16	25	21.5	10
5021600019	14	3/8	8	62.5	29.5	16	20	21.5	10
5021600020	14	1/2	9.5	62.5	31	16	25	21.5	10
5021600021	6	M12x1	7.5	42	22	11	16	12.5	10
5021600022	6	M12x1.25	7.5	42	22	11	16	12.5	10
5021600023	6	M12x1.5	7.5	42	22	11	16	12.5	10

50223

ТРОЙНИК ПОВОРОТНЫЙ Т-образный НАРУЖНЯЯ РЕЗЬБА (SHORT)- ORIENTING TEE MALE ADAPTOR (SHORT) OFF - SET LEG

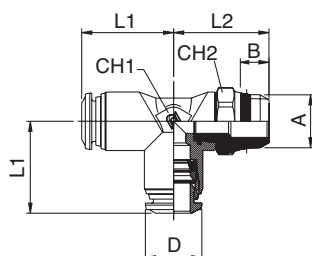

Код Code	Трубка Tube	A	B	L1	L2	CH1	CH2	D	Упак. Pack.
5022300001	4	1/8	5.5	17	20	9	13	10	10
5022300002	4	1/4	7	17	21.5	9	15	10	10
5022300003	5	1/8	5.5	20	22	11	13	12.5	10
5022300004	6	1/8	5.5	21	22	11	13	12.5	10
5022300005	6	1/4	7	21	23.5	11	15	12.5	10
5022300006	8	1/8	5.5	22.5	25	13	13	14.5	10
5022300007	8	1/4	7	22.5	25	13	15	14.5	10
5022300008	8	3/8	7.5	22.5	28	13	17	14.5	10
5022300009	8	1/2	9	22.5	28	13	21	14.5	10
5022300010	10	1/4	7	26.5	26	14	16	17.5	10
5022300011	10	3/8	7.5	26.5	26	14	17	17.5	10
5022300012	10	1/2	9	26.5	28.5	14	21	17.5	10
5022300013	12	3/8	7.5	31.5	29.5	16	20	21.5	10
5022300014	12	1/2	9	31.5	32	16	21	21.5	10

50226

УГЛОВОЕ ПОВОРОТНОЕ СОЕДИНЕНИЕ НАРУЖНЯЯ РЕЗЬБА (ЦИЛИНДРИЧЕСКАЯ) - ORIENTING TEE MALE ADAPTOR (PARALLEL) OFF - SET LEG

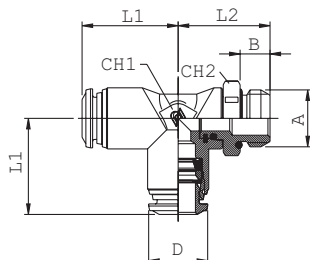
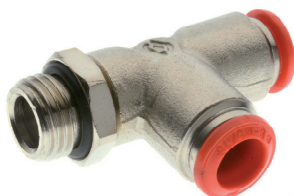

Код Code	Трубка Tube	A	B	L1	L2	CH1	CH2	D	Упак. Pack.
5022600001	3	M5	3.5	16.5	17	9	8	10	10
5022600002	4	M5	3.5	17	18	9	8	10	10
5022600003	4	1/8	5.5	17	18.5	9	13	10	10
5022600004	4	1/4	7	17	20	9	16	10	10
5022600005	5	M5	3.5	20	20.5	11	11	12.5	10
5022600006	5	1/8	5.5	20	20.5	11	13	12.5	10
5022600007	6	M5	3.5	21	20.5	11	11	12.5	10
5022600008	6	1/8	5.5	21	20.5	11	13	12.5	10
5022600009	6	1/4	7	21	22	11	16	12.5	10
5022600010	8	1/8	5.5	22.5	22.5	13	13	14.5	10
5022600011	8	1/4	7	22.5	24	13	16	14.5	10
5022600012	8	3/8	8	22.5	26	13	20	14.5	10
5022600013	8	1/2	9.5	22.5	27.5	13	25	14.5	10
5022600014	10	1/4	7	26.5	27	14	16	17.5	10
5022600015	10	3/8	8	26.5	26.5	14	20	17.5	10
5022600016	10	1/2	9.5	26.5	28	14	25	17.5	10
5022600017	12	3/8	8	31.5	29.5	16	20	21.5	10
5022600018	12	1/2	9.5	31.5	31	16	25	21.5	10
5022600021	6	M12x1	7.5	21	22	11	16	12.5	10
5022600022	6	M12x1.25	7.5	21	22	11	16	12.5	10
5022600023	6	M12x1.5	7.5	21	22	11	16	12.5	10

50230

ТРОЙНИК Т-образный - TEE CONNECTOR

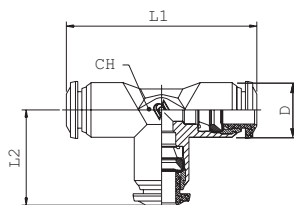

Код Code	Трубка Tube	L1	L2	CH	D	Упак. Pack.
5023000007	3	34	17	9	10	10
5023000001	4	34	17	9	10	10
5023000006	5	40	20	11	12.5	10
5023000002	6	42	21	11	12.5	10
5023000003	8	45	22.5	13	14	10
5023000004	10	53	26.5	16	17	10
5023000005	12	61	30.5	19	21.5	10
5023000008	14	65.5	32.5	19	21.5	10

50310

ТРОЙНИК Y-образный - Y CONNECTOR

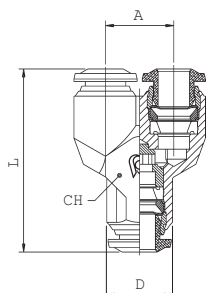

Код Code	Трубка Tube	A	L	CH	D	Упак. Pack.
5031000007	3	10	29	11	10	10
5031000001	4	11	32	11	10	10
5031000004	5	13.5	35	13	12.5	10
5031000002	6	13.5	36.5	13	12.5	10
5031000003	8	15.5	41	15	14	10
5031000008	10	18.5	48	18	17	10

50500

СОЕДИНЕНИЕ БАНДЖО - SINGLE BANJO BODY

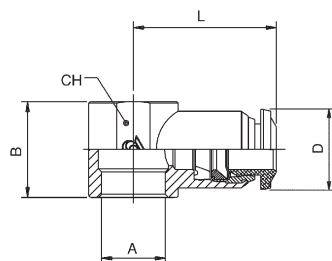

Код Code	Трубка Tube	A	B	L	CH	D	Упак. Pack.
505000019	3	M5	12.5	19	-	10	10
505000020	3	M6	12.5	19	-	10	10
505000001	4	M5	12.5	19	-	10	10
505000002	4	M6	12.5	19	-	10	10
505000003	4	1/8	15	21	14	10	10
505000013	5	M5	12.5	20	-	12.5	10
505000017	5	M6	12.5	20	-	12.5	10
505000014	5	1/8	15	21.5	14	12.5	10
505000015	5	1/4	17	24.5	18	12.5	10
505000016	6	M5	12.5	20.5	-	12.5	10
505000018	6	M6	12.5	20.5	-	12.5	10
505000004	6	1/8	15	22	14	12.5	10
505000005	6	1/4	17	25	18	12.5	10
505000006	8	1/8	15	24	14	14	10
505000007	8	1/4	17	26	18	14	10
505000008	8	3/8	20	28	21	14	10
505000009	10	1/4	17	29	18	17	10
505000010	10	3/8	20	30.5	21	17	10
505000012	12	3/8	20	32.5	21	21.5	10
505000021	12	1/2	24	35	25	21.5	10
505000022	14	1/2	24	35.5	25	21.5	10

50510

СОЕДИНЕНИЕ БАНДЖО - DOUBLE BANJO BODY

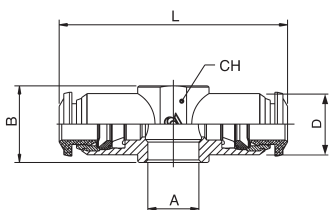

Код Code	Трубка Tube	A	B	L	CH	D	Упак. Pack.
505100001	4	M5	12.5	38	-	10	10
505100002	4	M6	12.5	38	-	10	10
505100003	4	1/8	15	42	14	10	10
505100008	5	1/8	15	43	14	12.5	10
505100009	5	1/4	17	49	18	12.5	10
505100004	6	1/8	15	44	14	12.5	10
505100005	6	1/4	17	50	18	12.5	10
505100006	8	1/8	15	48	14	14	10
505100007	8	1/4	17	52	18	14	10

50550

СОЕДИНЕНИЕ ПОВОРОТНОЕ БАНДЖО - ORIENTING SINGLE BANJO BODY MALE

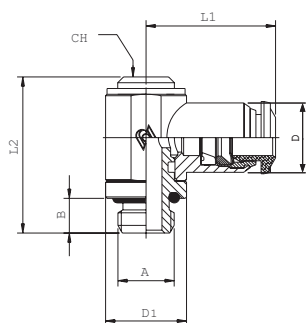

Код Code	Трубка Tube	A	B	L1	L2	CH	D1	D	Упак. Pack.
505500001	4	M5	3.6	19	24.5	-	CH8	10	10
505500002	4	1/8	6	21	28	5	14	10	10
505500012	5	M5	3.6	20	24.5	-	CH8	12.5	10
505500013	5	1/8	6	21.5	28	5	14	12.5	10
505500014	5	1/4	8	24.5	31	6	18	12.5	10
505500015	6	M5	3.6	20.5	24.5	-	CH8	12.5	10
505500003	6	1/8	6	22.5	28	5	14	12.5	10
505500004	6	1/4	8	25	31	6	18	12.5	10
505500005	8	1/8	6	24	28	5	14	14	10
505500006	8	1/4	8	26	31	6	18	14	10
505500007	8	3/8	9	28	35.5	7	21	14	10
505500008	10	1/4	8	29	31	6	18	17	10
505500009	10	3/8	9	30.5	35.5	7	21	17	10
505500011	12	3/8	9	32.5	35.5	7	21	21.5	10

50560

СОЕДИНЕНИЕ ПОВОРОТНОЕ БАНДЖО - ORIENTING DOUBLE BANJO BODY MALE

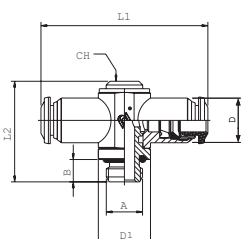

Код Code	Трубка Tube	A	B	L1	L2	D1	CH	D	Упак. Pack.
505600002	4	1/8	6	42	27	14	5	10	10
505600008	5	1/8	6	43	27	14	5	12.5	10
505600009	5	1/4	8	49	31	18	6	12.5	10
505600003	6	1/8	6	45	27	14	5	12.5	10
505600004	6	1/4	8	50	31	18	6	12.5	10
505600005	8	1/8	6	48	27	14	5	14	10
505600006	8	1/4	8	52	31	18	6	14	10

51410

БОЛТ БАНЖДО ОДИНАРНЫЙ - BANJO STEM SINGLE

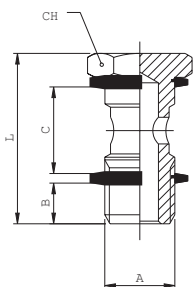

Код Code	A	B	C	L	CH	Упак. Pack.
5141000011	M5	4	12.5	22	8	25
5141000012	M6	5	12.5	23	8	25
5141000013	1/8	6	15	28	14	25
5141000014	1/4	8	17	32	17	25
5141000015	3/8	9	20	36	19	25
5141000016	1/2	10	24	42	24	25
5141000017	*M12x1.58	17	32	17		25

ДАННОЕ ИЗДЕЛИЕ ПОСТАВЛЯЕТСЯ С ЦАНГОЙ PA66 (ART. 1610).
THIS ITEM WILL BE SUPPLIED WITH THE PA66 WASHERS (ART. 1610).

*ИСПОЛЬЗУЕТСЯ В ПОВОРОТНЫХ СОЕДИНЕНИЯХ БАНЖДО 1/4.
*WITH THIS BANJO STEM USING 1/4 ORIENTING BANJO BODY.

51420

БОЛТ БАНЖДО ДВОЙНОЙ - BANJO STEM DOUBLE

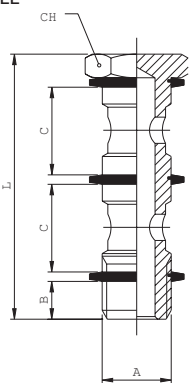

Код Code	A	B	C	L	CH	Упак. Pack.
5142000011	1/8	6	15	44.5	14	25
5142000012	1/4	8	17	50.5	17	25
5142000013	3/8	9	20	58	19	25
5142000014	1/2	10	24	68	24	25
5142000015	*M12x1.5	8	17	50.5	17	25

ДАННОЕ ИЗДЕЛИЕ ПОСТАВЛЯЕТСЯ С ЦАНГОЙ PA66 (ART. 1610).
THIS ITEM WILL BE SUPPLIED WITH THE PA66 WASHERS (ART. 1610).

*ИСПОЛЬЗУЕТСЯ В ПОВОРОТНЫХ СОЕДИНЕНИЯХ БАНЖДО 1/4.
*WITH THIS BANJO STEM USING 1/4 ORIENTING BANJO BODY.

51430

БОЛТ БАНЖДО ТРОЙНОЙ - BANJO STEM TRIPLE

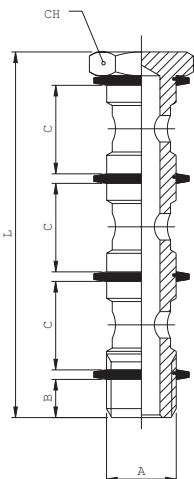

Код Code	A	B	C	L	CH	Упак. Pack.
5143000011	1/8	6	15	61	14	25
5143000012	1/4	8	17	69	17	25
5143000013	3/8	9	20	80	19	25
5143000014	1/2	10	24	94	24	10

ДАННОЕ ИЗДЕЛИЕ ПОСТАВЛЯЕТСЯ С ЦАНГОЙ PA66 (ART. 1610).
THIS ITEM WILL BE SUPPLIED WITH THE PA66 WASHERS (ART. 1610).

51440

БОЛТ БАНЖДО ОДИНАРНЫЙ - MALE - FEMALE BANJO STEM SINGLE

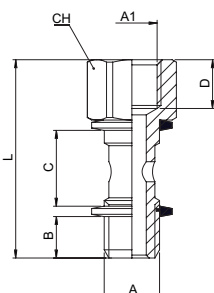

Код Code	A	A1	B	C	D	L	CH	Упак. Pack.
5144000001	1/8	1/8	6	15	8.5	34.5	14	25
5144000002	1/4	1/4	8	17	11	40.5	17	25
5144000003	3/8	3/8	9	20	12	45.5	19	25

ДАННОЕ ИЗДЕЛИЕ ПОСТАВЛЯЕТСЯ С ЦАНГОЙ PA66 (ART. 1610).
THIS ITEM WILL BE SUPPLIED WITH THE PA66 WASHERS (ART. 1610).

50600

СОЕДИНЕНИЕ НАРУЖНАЯ РЕЗЬБА (ЦИЛИНДРИЧЕСКАЯ) - MALE ADAPTOR PARALLEL

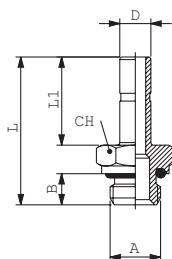

Код Code	D	A	B	L	L1	CH	Упак. Pack.
506000001	4	M5	4	24	15	8	10
506000002	4	1/8	6	26.5	15	13	10
506000012	5	M5	4	26	17	8	10
506000013	5	1/8	6	28.5	17	13	10
506000014	5	1/4	8	31	17	16	10
506000015	6	M5	4	26	17	8	10
506000003	6	1/8	6	28.5	17	13	10
506000004	6	1/4	8	31	17	16	10
506000005	8	1/8	6	29.5	18	13	10
506000006	8	1/4	8	32	18	16	10
506000007	8	3/8	9	33.5	18	20	10
506000016	10	1/8	6	33.5	22	13	10
506000008	10	1/4	8	36	22	16	10
506000009	10	3/8	9	37.5	22	20	10
506000010	12	1/4	8	38.5	24.5	16	10
506000011	12	3/8	9	40	24.5	20	10

8610

ПОЛИАМИДНАЯ ЗАГЛУШКА - POLYAMIDE PLUG

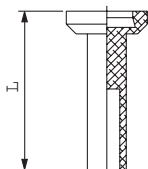

Код Code	Трубка Tube	L	Упак. Pack.
086100031X0RO	3	18	25
086100031X1RO	4	23.5	25
086100031X3RO	5	24.5	25
086100031X4RO	6	24.5	25
086100031X7RO	8	26	25
086100031X9RO	10	28.5	25
086100031Y1RO	12	28.5	25
086100031Y3RO	14	28.5	20

50625

ДВОЙНОЕ СОЕДИНЕНИЕ - DOUBLE JOINT

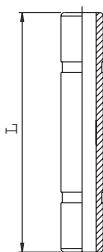

Код Code	Трубка Tube	L	Упак. Pack.
506250001X1NB	4	31	10
506250001X3NB	5	33	10
506250001X4NB	6	34	10
506250001X7NB	8	36	10
506250001X9NB	10	45	10
506250001Y1NB	12	50	10

50700

ПЕРЕХОДНИК - REDUCER

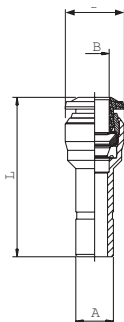

Код Code	A	B	L	D	Упак. Pack.
507000006	4	3	30	8.5	10
507000004	5	4	32	11.5	10
507000001	6	4	30	10.5	10
507000005	6	5	34.5	11.5	10
507000008	8	4	32.5	10.5	10
507000002	8	6	34.5	12.5	10
507000009	10	4	31.5	10.5	10
507000011	10	6	37.5	12.5	10
507000003	10	8	38.5	14.5	10
507000007	12	8	39.5	14.5	10
507000010	12	10	43	17.5	10

55800R

ФИТИНГ-КАРТРИДЖ - PUSH-FIT CARTRIDGES

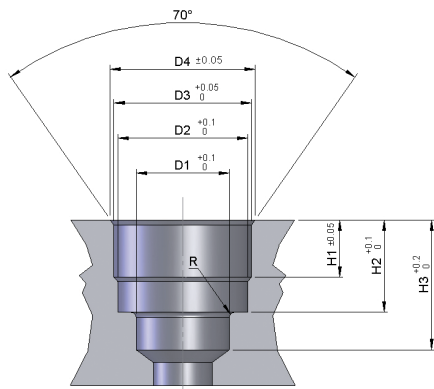
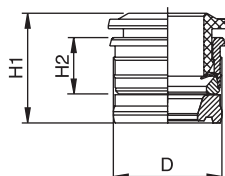

Код Code	Трубка Tube	D	H1	H2	Упак. Pack.
558000008	3	6.7	9	5	25
558000001	4	8.7	11	5.6	25
558000002	5	9.75	11.8	6.3	25
558000003	6	10.75	12.4	6.9	25
558000004	8	12.7	12.4	6.9	25
558000005	10	15.7	15.7	8.5	25
558000006	12	18.3	17.8	9.5	25

55800

SEDE - SEAT

 ПОСАДОЧНЫЕ РАЗМЕРЫ ПОД ФИТИНГ_КАРТРИДЖ
 SEATS DIMENSIONS PUSH-FIT CARTRIDGES

Трубка Tube	D1	D2	D3	D4	H1	H2	H3	R
3	3.4	6.05	6.4	6.95	3.7	6.1	8.6	0.5
4	4.2	7.45	8.4	9	3.75	6.5	9.5	0.5
5	5.2	8.35	9.4	10.15	4.45	7.9	10.5	0.5
6	6.2	9.35	10.45	11.35	5	8.5	11.5	0.5
8	8.2	11.4	12.4	12.9	5.2	8.5	12.5	0.75
10	10.2	14.5	15.4	16	6.7	10.5	15	0.75
12	12.2	17	18	19	7.5	12.1	17	1

55801

СВЕРЛО

TOOL FOR PUSH-FIT CARTRIDGES SEAT



Код Code	Трубка Tube	Ø Корпуса Body	Упак. Pack.
558010007	3	10	1
558010001	4	10	1
558010006	5	12	1
558010002	6	12	1
558010003	8	12	1
558010004	10	16	1
558010005	12	16	1

55802

 ИНСТРУМЕНТ ДЛЯ УСТАНОВКИ ФИТИНГА-КАРТРИДЖА
 ASSEMBLING TOOL FOR PUSH-FIT CARTRIDGES

Код Code	Трубка Tube	Упак. Pack.
558020001	3	1
558020002	4	1
558020003	5	1
558020004	6	1
558020005	8	1
558020006	10	1
558020007	12	1

ИНСТРУКЦИЯ ПО УСТАНОВКЕ ФИТИНГА-КАРТРИДЖА ART. 55800R PUSH-FIT CARTRIDGES ASSEMBLING INSTRUCTIONS ART. 55800R

Просверлите отверстие с помощью сверла Art. 55801
 Make the seat for the cartridge utilizing the suitable tool Art. 55801

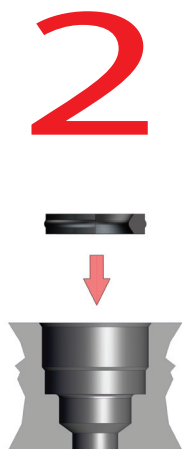
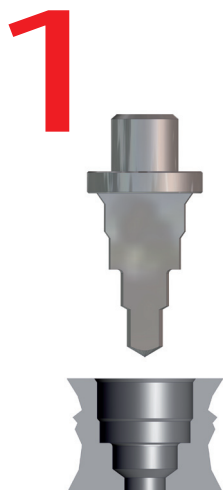

Установите прокладку в отверстие.
 Insert the lip seal inside of the seat.

ПОМЕСТИТЕ КАРТРИДЖ В ИНСТРУМЕНТ ДЛЯ УСТАНОВКИ Art. 55802
 Insert the cartridge into the assembling tool Art. 55802

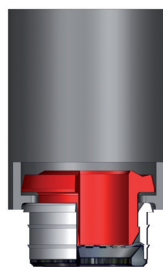

3

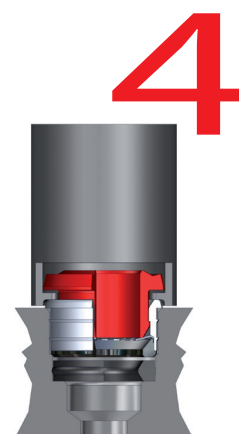

Запресуйте картридж при помощи инструмента для установки в посадочное отверстие до упора.
 Press the cartridge inside of the seat until it will be reached the abutment surface with the assembling tool.

50900

КОЛЛЕКТОР 5 ВЫВОДОВ - ALUMINIUM MANIFOLD 5 WAYS

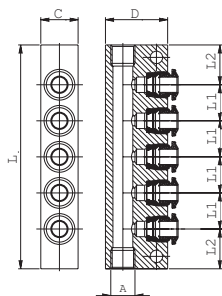
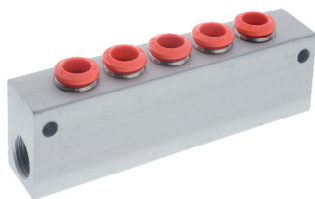

Код Code	Трубка Tube	A	C	D	L	L1	L2	Упак. Pack.
5090000001	4	1/8	15	25	75	12	13.5	5
5090000002	6	1/8	15	25	90	14.5	16	5
5090000003	6	1/4	20	30	90	14.5	16	5
5090000004	8	1/4	20	30	100	16	18	5

50980

СТОПОРНАЯ КЛИПСА - SECURITY CLIPS

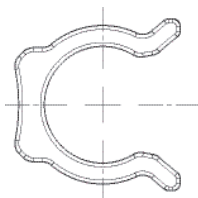
NEW

Код Code	Трубка Tube	Упак. Pack.
509800032X1RO	4-(5/32)	50
509800032X3RO	5	50
509800032X4RO	6-(1/4)	50
509800032X7RO	8-(5/16)	50
509800032X9RO	10-(3/8)	50
509800032Y1RO	12-(1/2)	50
509800032Y3RO	14	50

50990

СЪЕМНИК - TOOL FOR DISASSEMBLING

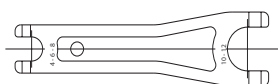

Код Code	Упак. Pack.
5099000001	10

50006

РЕЗЬБОВЫЕ УПЛОТНЕНИЯ - THREAD PACKING FOR TAPER THREADS



Код Code	Резьба Thread	Упак. Pack.
5000600240200	1/8	10
5000600240300	1/4	10
5000600240400	3/8	10
5000600240500	1/2	10

