



G

# Серия Ghilux

Краны шаровые  
Ball valves

## Технические характеристики / Technical Characteristics

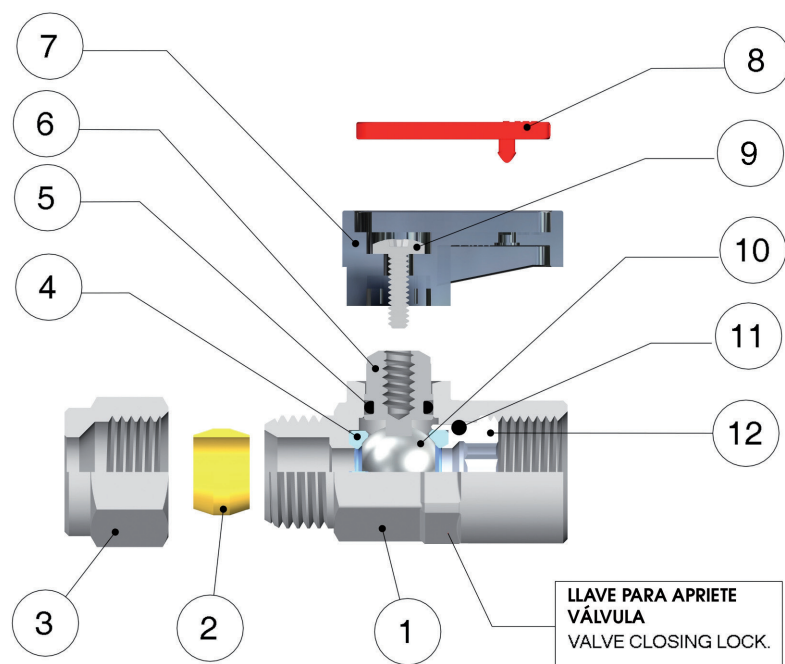
 FKM ПО ЗАПРОСУ  
IF REQUESTED FKM

**BS EN 331:1998**

 Tested by GL to  
BS EN 331:1998

## Части и материалы / Component Parts and Materials

1 Хромированный латунный корпус	1 Chrome Nickel-plated Brass Body
2 Латунное врезное кольцо (PTFE по запросу)	2 Brass Olive(if Requested PTFE)
3 Хромированная гайка	3 Chrome Nickel-plated Brass Nut
4 Седло из PTFE	4 PTFE Seats
5 Уплотнительное кольцо из NBR 70 (FKM по запросу)	5 NBR 70 Seal O-RING (FKM if required)
6 Хромированный шток	6 Chrome Nickel-plated Brass Spindle
7 Рукоятка из PA66 армированная стекловолокном	7 PA66 Glass reinforced Handle
8 Накладка из ацетальной смолы	8 Acetalic resin Plate
9 Стальной винт	9 Steel Screw
10 Хромированный шарик	10 Chrome Nickel-plated Brass Ball
11 Уплотнительное кольцо из NBR 70 (FKM по запросу)	11 NBR 70 Seal O-RING (FKM if required)
12 Латунный фитинг	12 Brass Fitting

## Давление / Pressures

 Минимальное давление / Minimum Pressure: -0.99 bar (-0.099MPa)  
 Максимальное давление / Maximum pressure: 20 bar (2 MPa)

## Резьбы / Threads

 Коническая ISO 7.1, BS 21, DIN 2999 / Tapered gas in conformity with ISO7.1, BS 21, DIN 2999.  
 Цилиндрическая ISO 228 Classe A / Parallel gas in conformity with ISO 228 Class A.

## Соединяемые трубки / Connection Tubes

 Трубы из меди, стали, и различные фитинги  
 PA6, PA11, FEP, PTFE. с внутренней переходной втулкой  
 art. 10770.

 Tubes made in copper, metal in general and various fittings.  
 PA6, PA11, FEP, PTFE. with an inside support bush art 10770.

## Температура / Temperatures

 Минимальная температура / Minimum temperature: -20 °C  
 Максимальная температура / Maximum temperature: +80 °C

С уплотнениями из FKM / With FKM Seals

 Минимальная температура / Minimum temperature: -15 °C  
 Максимальная температура / Maximum temperature: +130 °C

## Рабочая среда / Fluids

Сжатый воздух, вода, масло.

\*Искусственные и природные газы под средним давлением.

 Сжиженный легковоспламеняющийся газ под низким давлением.  
 Compressed air, water, oils.

\*1st and 2nd family gases at medium pressure.

3rd family gases at low pressure.

ДИАГРАММА ДАВЛЕНИЕ-ТЕМПЕРАТУРА  
PRESSURE-TEMPERATURE RATINGS DIAGRAM

- PTFE + NBR
- PTFE + FKM

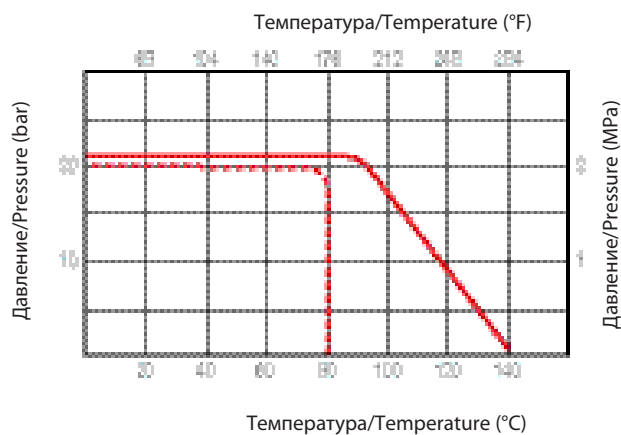

КРИВЫЕ РАСХОДА ВОЗДУХА ДЛЯ ШАРОВЫХ КРАНОВ СЕРИИ GHILUX ART. 6400  
CHARACTERISTIC CURVES OF FLOW FOR AIR  
PERTINENT TO THE BALL VALVES GHILUX ART. 6400 FEMALE-FEMALE

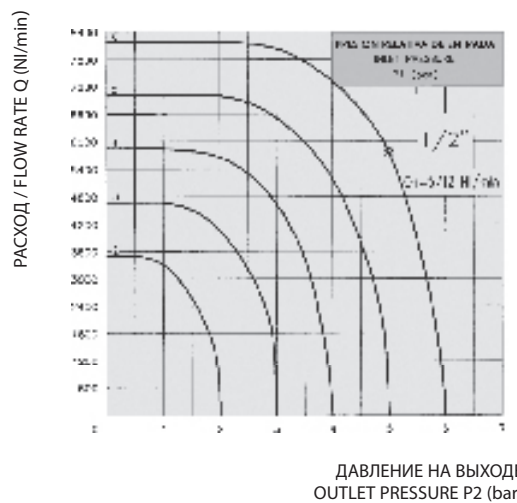
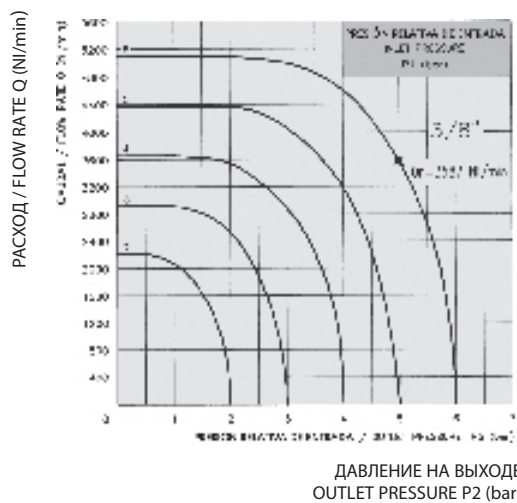
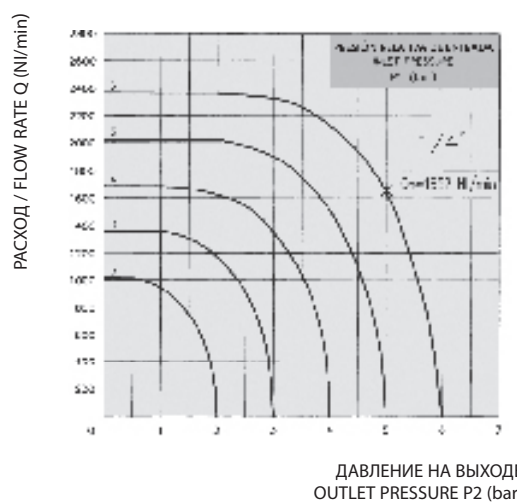
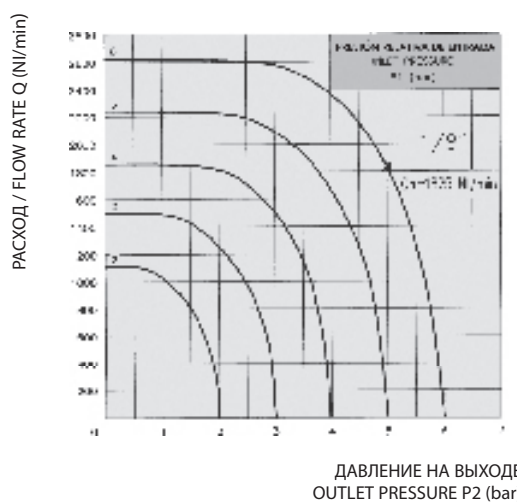

РАСХОД / FLOW RATE Q (l/min)

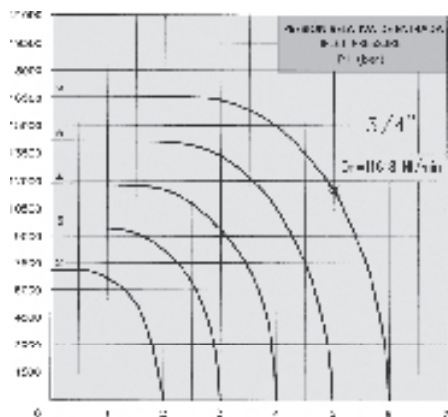
 ДАВЛЕНИЕ НА ВЫХОДЕ  
 OUTLET PRESSURE P2 (bar)

На различных диаграммах указаны значения расхода Qn соответствующие давлению P1 = 6 bar и давлению P2 = 5 bar.

On the different diagrams is marked the value of flow rate Qn pertinent to a pressure P1 = 6 bar and to a pressure P2 = 5 bar.

ПРОТОКОЛ ИСПЫТАНИЙ № 36794 ВЫДАН "ISTITUTO GIORDANO" ОТ 13/06/1990.

TEST CERTIFICATE № 36794 ISSUED BY THE "ISTITUTO GIORDANO" ON THE 13/06/1990.

### ДИАГРАММА РАСХОДА И ПАДЕНИЯ ДАВЛЕНИЯ ВОДЫ ДЛЯ ШАРОВЫХ КРАНОВ СЕРИИ GHILUX ART. 6400

### DIAGRAM OF THE FLOW RATE AND PRESSURE DROP CHARACTERISTICS PERTINENT TO THE BALL VALVES GHILUX ART. 6400 FEMALE-FEMALE FOR WATER

ПАДЕНИЕ ДАВЛЕНИЯ / PRESSURE DROP Δp (daPa) 1 daPa = 1,019 mm H2O

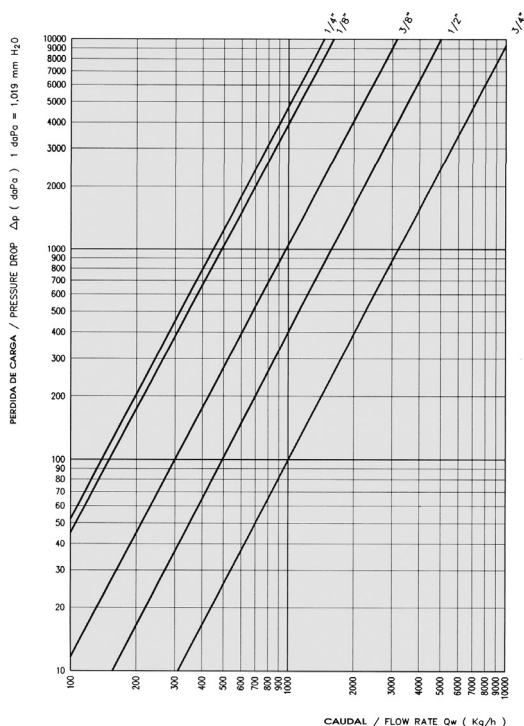

РАСХОД / FLOW RATE Qw (kg/h)

### КОЭФФИЦИЕНТ РАСХОДА Kv FLOW RATE FACTORS Kv

В следующих таблицах приводится коэффициент расхода Kv шаровых кранов серии GHILUX, напоминаем что этот коэффициент показывает количество воды проходящей через кран в единицу времени (Kg/ч) при температуре 15.5° C и определяет падение давления.

On the following table we specify the flow rate factor Kv of the ball valves GHILUX, we remind You that this factor represent the quantity of water that cross the valve in the unit time (Kg/h) at the temperature of 15.5° C and it determines a drop of unitary pressure.

Размер Size	Коэффициент расхода Factor of hydraulic flow rate Kv (Kg/h)
1/8"	1614
1/4"	1461
3/8"	3164
1/2"	5051
3/4"	10274

Протокол испытаний N. 36547 выдан "ISTITUTO GIORDANO" от 31/05/1990  
 TEST CERTIFICATE N. 36547 ISSUED BY THE "ISTITUTO GIORDANO" ON THE 31/05/1990

## КАК ЗАКАЗАТЬ

Шаровые краны серии GHILUX поставляются с:

- Хромированными поверхностями
- Латунное врезное кольцо
- Короткой ручкой
- Красной накладкой

Для заказа стандартного изделия просто укажите артикул, размер и количество.

Любое отклонение от стандартного необходимо указать в описании в заказе (например длинная ручка, зеленая накладка, и т.д.).

## HOW TO ORDER

The ball valves GHILUX series are supplied with:

- Surface treatment of CHROME-NICKEL PLATED
- BRASS Olive
- SHORT Handle
- RED Plate

To order the standard items simply specify the ARTICLE CODE, SIZE and QUANTITY.

Every kind of changes must be specified on the order using a description (ex. LONG handle, GREEN plate, etc.).

# 6430

КРАН ТРУБКА - ВНУТР. РЕЗЬБА G ISO 228 (СТАНДАРТНАЯ РУЧКА - КРАСНАЯ НАКЛАДКА)

TUBE - FEMALE G ISO 228 VALVE (STANDARD HANDLE - RED PLATE)



Код Code	D	B	DN	ES	M	L	G	H	Упак. Pack.
0643000001	6	1/8	5.5	14-15	7	41	19	21	25
0643000002	8	1/8	5.5	14-15	7	43	19	21	25
0643000003	8	1/4	5.5	14-15	8	43	19	21	25
0643000004	10	3/8	8	18-19	9	48	19	22	10
0643000005	12	3/8	8	18-19	9	49	19	22	10
0643000006	14	1/2	10	22-23	10	55.5	26	30.5	10
0643000007	15	1/2	10	22-23	10	55.5	26	30.5	10
0643000098	16	3/4	14	28-30	12	63.5	50	33	5
0643000099	18	3/4	14	28-30	12	63.5	50	33	5

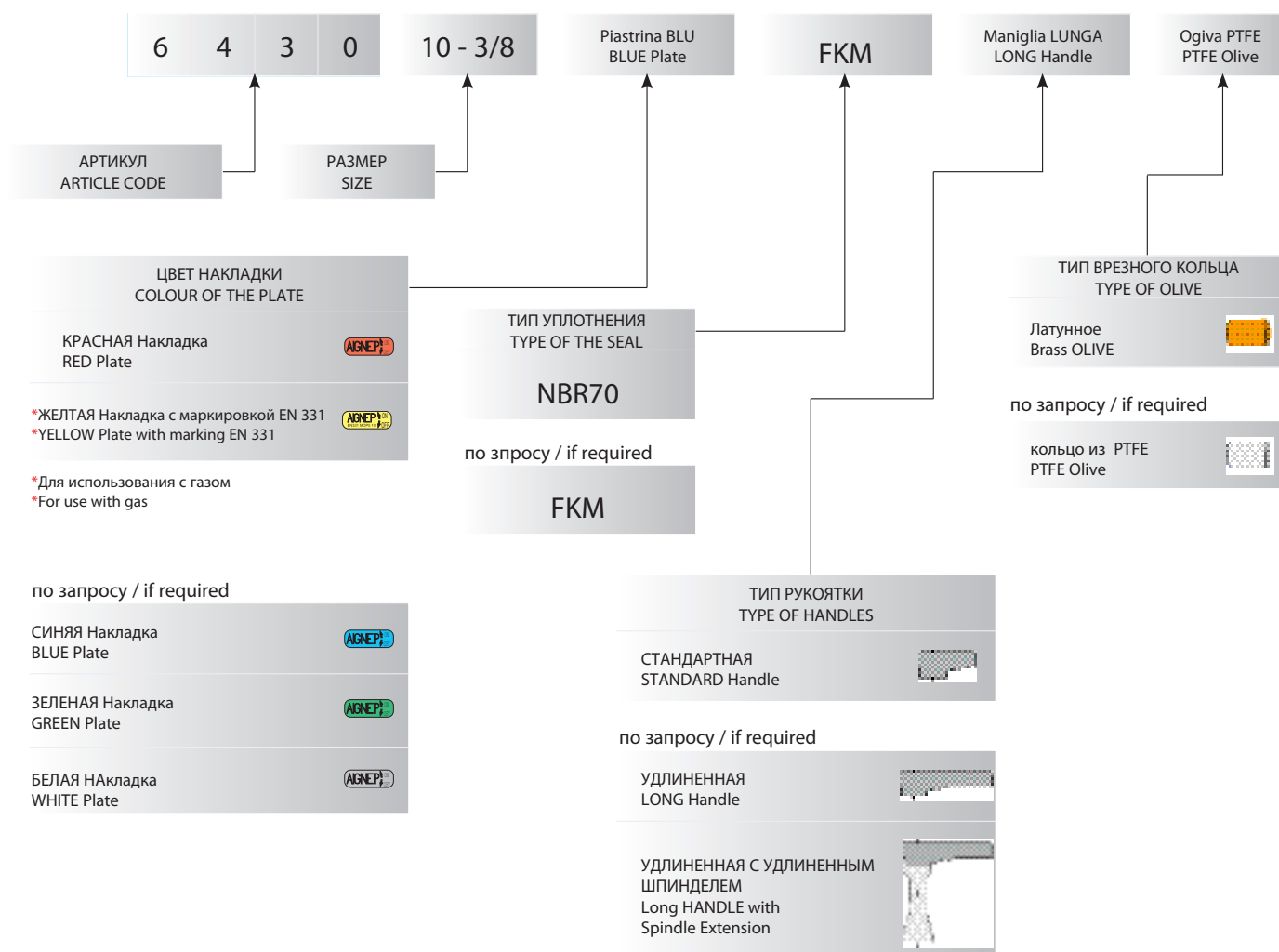

## 6300

КРАН RP ISO 7 - RP ISO 7 (СТАНДАРТНАЯ РУЧКА - КРАСНАЯ НАКЛАДКА)  
 FEMALE RP ISO 7 - FEMALE RP ISO 7 VALVE (STANDARD HANDLE - RED PLATE)

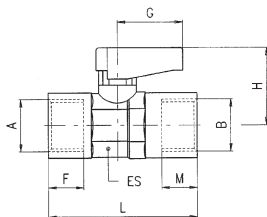

Код Code	A	B	DN	ES	F	M	L	G	H	Упак. Pack.
0630000001	1/8	1/8	5.5	14-15	7.4	7.4	36	19	21	25
0630000002	1/4	1/4	5.5	14-15	11	11	43	19	21	25
0630000003	3/8	3/8	8	18-19	11.4	11.4	47	19	22	10
0630000004	1/2	1/2	10	22-23	15	15	59	26	30.5	10
0630000055	3/4	3/4	14	28-30	16.3	16.3	67	50	33	5

## 6310

КРАН КОНИЧЕСКАЯ R ISO 7 - RP ISO 7 (СТАНДАРТНАЯ РУЧКА - КРАСНАЯ НАКЛАДКА)  
 TAPER MALE R ISO 7 - FEMALE RP ISO 7 VALVE (STANDARD HANDLE - RED PLATE)

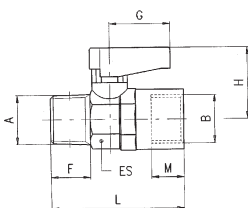

Код Code	A	B	DN	ES	F	M	L	G	H	Упак. Pack.
0631000001	1/8	1/8	5.5	14-15	7.4	7.4	36	19	21	25
0631000002	1/4	1/8	5.5	14-15	11	7.4	40.5	19	21	25
0631000003	1/4	1/4	5.5	14-15	11	11	43	19	21	25
0631000004	3/8	3/8	8	18-19	11.4	11.4	46	19	22	10
0631000005	1/2	1/2	10	22-23	15	15	57	26	30.5	10
0631000066	3/4	3/4	14	28-30	16.3	16.3	63	50	33	5

## 6320

КРАН ЦИЛИНДРИЧЕСКАЯ GA ISO 228 - RP ISO 7 (СТАНДАРТНАЯ РУЧКА - КРАСНАЯ НАКЛАДКА)  
 PARALLEL MALE GA ISO 228 - FEMALE RP ISO 7 VALVE (STANDARD HANDLE - RED PLATE)

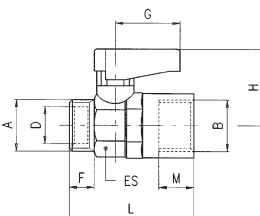

Код Code	A	B	DN	ES	D	F	M	L	G	H	Упак. Pack.
0632000001	1/8	1/8	5.5	14-15	6.2	7	7.4	34.5	19	21	25
0632000002	1/4	1/8	5.5	14-15	8.2	8	7.4	35.5	19	21	25
0632000003	1/4	1/4	5.5	14-15	8.2	8	11	38	19	21	25
0632000004	3/8	3/8	8	18-19	10.2	9	11.4	41.5	19	22	10
0632000005	1/2	1/2	10	22-23	15.2	10	15	50	26	30.5	10
0632000066	3/4	3/4	14	28-30	18.2	12	16.3	56.5	50	33	5

## 6330

КРАН КОНИЧЕСКАЯ R ISO 7 - ЦИЛИНДРИЧЕСКАЯ GA ISO 228 (СТАНДАРТНАЯ РУЧКА - КРАСНАЯ НАКЛАДКА)  
 TAPER MALE R ISO 7 - PARALLEL MALE GA ISO 228 VALVE (STANDARD HANDLE - RED PLATE)

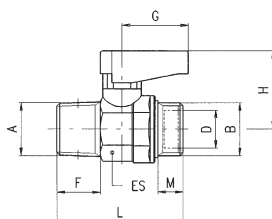

Код Code	A	B	DN	ES	D	F	M	L	G	H	Упак. Pack.
0633000001	1/8	1/8	5.5	14-15	6.2	7.4	7	33.5	19	21	25
0633000002	1/8	1/4	5.5	14-15	8.2	7.4	8	33.5	19	21	25
0633000003	1/4	1/8	5.5	14-15	6.2	11	7	38	19	21	25
0633000004	1/4	1/4	5.5	14-15	8.2	11	8	38	19	21	25
0633000005	3/8	3/8	8	18-19	10.2	11.4	9	41.5	19	22	10
0633000006	1/2	1/2	10	22-23	15.2	15	10	49	26	30.5	10
0633000077	3/4	3/4	14	28-30	18.2	16.3	12	55.5	50	33	5

## 6340

КРАН ТРУБА - RP ISO 7 (СТАНДАРТНАЯ РУЧКА - КРАСНАЯ НАКЛАДКА)  
TUBE - FEMALE RP ISO 7 VALVE (STANDARD HANDLE - RED PLATE)

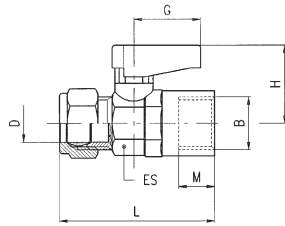

Код Code	D	B	DN	ES	M	L	G	H	Упак. Pack.
0634000001	6	1/8	5.5	14-15	7.4	41.5	19	21	25
0634000002	8	1/8	5.5	14-15	7.4	43	19	21	25
0634000003	8	1/4	5.5	14-15	11	46	19	21	25
0634000004	10	3/8	8	18-19	11.4	50.5	19	22	10
0634000005	12	3/8	8	18-19	11.4	51.5	19	22	10
0634000006	14	1/2	10	22-23	15	61.5	26	30.5	10
0634000007	15	1/2	10	22-23	15	61.5	26	30.5	10
0634000008	16	3/4	14	28-30	16.3	68	50	33	5
0634000009	18	3/4	14	28-30	16.3	68	50	33	5

## 6350

КРАН КОНИЧЕСКАЯ R ISO 7 - ТРУБА (СТАНДАРТНАЯ РУЧКА - КРАСНАЯ НАКЛАДКА)  
TAPER MALE R ISO 7 - TUBE VALVE (STANDARD HANDLE - RED PLATE)

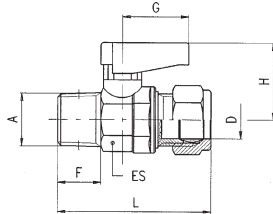

Код Code	A	D	DN	ES	F	L	G	H	Упак. Pack.
0635000001	1/8	6	5.5	14-15	7.4	40.5	19	21	25
0635000002	1/8	8	5.5	14-15	7.4	41.5	19	21	25
0635000003	1/4	6	5.5	14-15	11	46	19	21	25
0635000004	1/4	8	5.5	14-15	11	45	19	21	25
0635000005	3/8	10	8	18-19	11.4	50.5	19	22	10
0635000006	3/8	12	8	18-19	11.4	51.5	19	22	10
0635000007	1/2	14	10	22-23	15	59.5	26	30.5	10
0635000008	1/2	15	10	22-23	15	59.5	26	30.5	10
0635000109	3/4	16	14	28-30	16.3	67	50	33	5
0635000110	3/4	18	14	28-30	16.3	67	50	33	5

## 6400

КРАН G ISO 228 - G ISO 228 (СТАНДАРТНАЯ РУЧКА - КРАСНАЯ НАКЛАДКА)  
FEMALE G ISO 228 - FEMALE G ISO 228 VALVE (STANDARD HANDLE - RED PLATE)

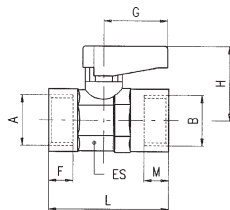

Код Code	A	B	DN	ES	F	M	L	G	H	Упак. Pack.
0640000001	1/8	1/8	5.5	14-15	7	7	35	19	21	25
0640000002	1/4	1/4	5.5	14-15	8	8	37	19	21	25
0640000003	3/8	3/8	8	18-19	9	9	42	19	22	10
0640000004	1/2	1/2	10	22-23	10	10	49	26	30.5	10
0640000055	3/4	3/4	14	28-30	12	12	58	50	33	5

## 6410

КРАН ЦИЛИНДРИЧЕСКАЯ GA ISO 228 - G ISO 228 (СТАНДАРТНАЯ РУЧКА - КРАСНАЯ НАКЛАДКА)  
PARALLEL MALE GA ISO 228 - FEMALE G ISO 228 VALVE (STANDARD HANDLE - RED PLATE)

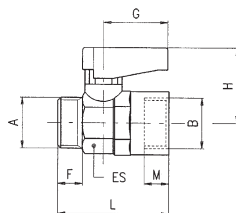

Код Code	A	B	DN	ES	F	M	L	G	H	Упак. Pack.
0641000001	1/8	1/8	5.5	14-15	7	7	34	19	21	25
0641000002	1/4	1/8	5.5	14-15	8	7	35	19	21	25
0641000003	1/4	1/4	5.5	14-15	8	8	35	19	21	25
0641000004	3/8	3/8	8	18-19	9	9	39	19	22	10
0641000005	1/2	1/2	10	22-23	10	10	45	26	30.5	10
0641000066	3/4	3/4	14	28-30	12	12	52	50	33	5

## 6420

КРАН ЦИЛИНДРИЧЕСКАЯ GA ISO 228 - ЦИЛИНДРИЧЕСКАЯ GA ISO 228 (СТАНДАРТНАЯ РУЧКА - КРАСНАЯ НАКЛАДКА)  
 PARALLEL MALE GA ISO 228 - PARALLEL MALE GA ISO 228 VALVE (STANDARD HANDLE - RED PLATE)

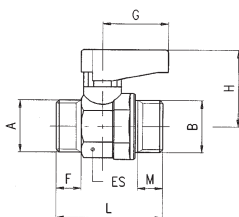

Код Code	A	B	DN	ES	F	M	L	G	H	Код. Pack.
0642000001	1/8	1/8	5.5	14-15	7	7	32	19	21	25
0642000002	1/8	1/4	5.5	14-15	7	8	32	19	21	25
0642000003	1/4	1/4	5.5	14-15	8	8	33	19	21	25
0642000004	3/8	1/4	5.5	14-15	9	8	33	19	21	25
0642000005	3/8	3/8	8	18-19	9	9	37	19	22	10
0642000006	1/2	3/8	8	18-19	10	9	37	19	22	10
0642000007	1/2	1/2	10	22-23	10	10	42	26	30.5	10
0642000008	3/4	1/2	10	22-23	12	10	42	50	30.5	10
0642000099	3/4	3/4	14	28-30	12	12	49	50	33	5

## 6430

КРАН ТРУБА - G ISO 228 (СТАНДАРТНАЯ РУЧКА - КРАСНАЯ НАКЛАДКА)  
 TUBE - FEMALE G ISO 228 VALVE (STANDARD HANDLE - RED PLATE)

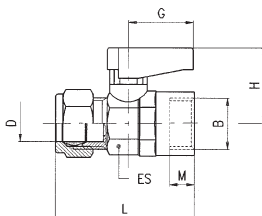

Код Code	D	B	DN	ES	M	L	G	H	Код. Pack.
0643000001	6	1/8	5.5	14-15	7	41	19	21	25
0643000002	8	1/8	5.5	14-15	7	43	19	21	25
0643000003	8	1/4	5.5	14-15	8	43	19	21	25
0643000004	10	3/8	8	18-19	9	48	19	22	10
0643000005	12	3/8	8	18-19	9	49	19	22	10
0643000006	14	1/2	10	22-23	10	55.5	26	30.5	10
0643000007	15	1/2	10	22-23	10	55.5	26	30.5	10
0643000098	16	3/4	14	28-30	12	63.5	50	33	5
0643000099	18	3/4	14	28-30	12	63.5	50	33	5

## 6440

КРАН ЦИЛИНДРИЧЕСКАЯ GA ISO 228 - ТРУБА (СТАНДАРТНАЯ РУЧКА - КРАСНАЯ НАКЛАДКА)  
 PARALLEL MALE GA ISO 228 - TUBE VALVE (STANDARD HANDLE - RED PLATE)

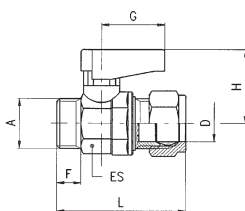

Код Code	A	D	DN	ES	F	L	G	H	Упак. Pack.
0644000001	1/8	6	5.5	14-15	7	39	19	21	25
0644000002	1/8	8	5.5	14-15	7	40	19	21	25
0644000003	1/4	6	5.5	14-15	8	40	19	21	25
0644000004	1/4	8	5.5	14-15	8	41	19	21	25
0644000005	1/4	10	5.5	14-15	8	44	19	21	25
0644000006	3/8	8	5.5	14-15	9	43	19	21	25
0644000007	3/8	10	8	18-19	9	46	19	22	10
0644000008	3/8	12	8	18-19	9	47	19	22	10
0644000009	3/8	14	8	18-19	9	50.5	19	22	10
0644000010	3/8	15	8	18-19	9	50.5	19	22	10
0644000011	1/2	10	8	18-19	10	49	19	22	10
0644000012	1/2	12	8	18-19	10	50	19	22	10
0644000013	1/2	14	10	22-23	10	52.5	26	30.510	
0644000014	1/2	15	10	22-23	10	52.5	26	30.510	
0644000015	3/4	14	10	22-23	12	56.5	26	30.510	
0644000016	3/4	15	10	22-23	12	56.5	26	30.510	
0644000197	3/4	16	14	28-30	12	60.5	50	33	5
0644000198	3/4	18	14	28-30	12	60.5	50	33	5

• Для размеров 1/4-8, 1/4-10, 3/8-14, 3/8-15 гайка, конус и резьба А находятся с противоположной стороны рисунка

• In the sizes 1/4-8, 1/4-10, 3/8-14, 3/8-15 the nut, the double cone and the thread A are at the opposite side of the picture.



## 6450

КРАН ТРУБА - ТРУБА (СТАНДАРТНАЯ РУЧКА - КРАСНАЯ НАКЛАДКА)  
TUBE - TUBE VALVE (STANDARD HANDLE - RED PLATE)

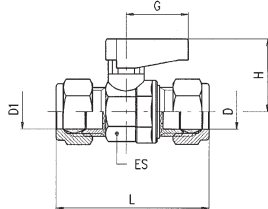

Код Code	D1	D	DN	ES	L	G	H	Упак. Pack.
0645000001	6	6	5.5	14-15	46	19	21	25
0645000002	6	8	5.5	14-15	48	19	21	25
0645000003	8	8	5.5	14-15	48	19	21	25
0645000004	10	8	5.5	14-15	51	19	21	25
0645000005	10	10	8	18-19	55	19	22	10
0645000006	10	12	8	18-19	56	19	22	10
0645000007	12	12	8	18-19	57	19	22	10
0645000008	14	10	8	18-19	59.5	19	22	10
0645000009	14	12	8	18-19	60.5	19	22	10
0645000010	15	10	8	18-19	59.5	19	22	10
0645000011	15	12	8	18-19	60.5	19	22	10
0645000012	14	14	10	22-23	63	26	30.5	10
0645000013	15	14	10	22-23	63	26	30.5	10
0645000014	15	15	10	22-23	63	26	30.5	10
0645000015	16	14	10	22-23	68	26	30.5	10
0645000016	16	15	10	22-23	68	26	30.5	10
0645000017	18	14	10	22-23	68	26	30.5	10
0645000018	18	15	10	22-23	68	26	30.5	10
06450000219	18	16	14	28-30	71	50	33	5
0645000220	18	18	14	28-30	71	50	33	5

## 6460

КРАН НАКИДНАЯ ГАЙГА - КОНИЧЕСКАЯ R ISO 7 (СТАНДАРТНАЯ РУЧКА - КРАСНАЯ НАКЛАДКА)  
MILLED NUT - TAPER MALE R ISO 7 VALVE (STANDARD HANDLE - RED PLATE)

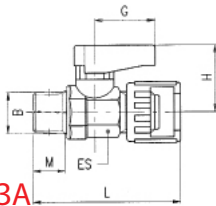

НЕ ДЛЯ ГАЗА

Код Code	B	DN	ES	M	L	G	H	Упак. Pack.
0646000001	1/8	5.5	14-15	7.4	44	19	21	10
0646000002	1/4	5.5	14-15	11	49.5	19	21	10
0646000003	3/8	8	18-19	11.4	50	19	21	10

## 6470

КРАН НАКИДНАЯ ГАЙКА - G ISO 228 (СТАНДАРТНАЯ РУЧКА - КРАСНАЯ НАКЛАДКА)  
MILLED NUT - FEMALE G ISO 228 VALVE (STANDARD HANDLE - RED PLATE)

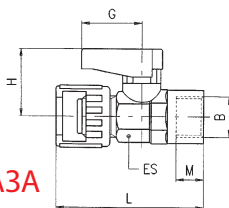

НЕ ДЛЯ ГАЗА

Код Code	B	DN	ES	M	L	G	H	Упак. Pack.
0647000001	1/8	5.5	14-15	7	46	19	21	10
0647000002	1/4	5.5	14-15	8	46	19	21	10

## 6490

КРАН НАСТЕННЫЙ (СТАНДАРТНАЯ РУЧКА - КРАСНАЯ НАКЛАДКА)  
FOOT MOUNTED FEMALE-FEMALE VALVE (STANDARD HANDLE - RED PLATE)

**NEW**

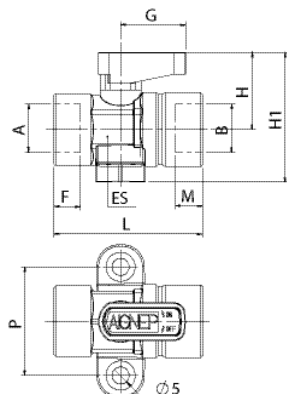

Код Code	A	B	DN	ES	L	F	M	G	H	H1	P	Упак. Pack.
0649000002	1/4	1/4	5,5	14-15	43,5	8	8	19	21	31,5	30	10
0649000003	3/8	3/8	8	18-19	8,5	9	9	19	22	38	32	10

## 6500

КРАН НАСТЕННЫЙ ТРУБА-ТРУБА (СТАНДАРТНАЯ РУЧКА - КРАСНАЯ НАКЛАДКА)  
 FOOT MOUNTED TUBE-TUBE VALVE (STANDARD HANDLE - RED PLATE)

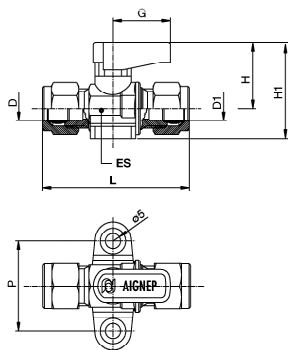

Код Code	D	D1	DN	ES	L	H	H1	G	P	Упак. Pack.
065000001	8	8	5.5	14-15	50	21	32	19	30	10

## 6540

КРАН УГЛОВОЙ ЦИЛИНДРИЧЕСКАЯ GA ISO 228-КОНИЧЕСКАЯ R ISO 7 (СТАНДАРТНАЯ РУЧКА - КРАСНАЯ НАКЛАДКА)  
 ELBOW PARALLEL MALE GA ISO 228-TAPER MALE R ISO 7 VALVE (STANDARD HANDLE - RED PLATE)

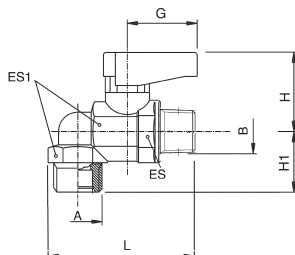

Код Code	A	B	DN	ES	ES1	L	H	H1	G	Упак. Pack.
065400001	1/4	1/4	5.5	14-15	17	48	21	17	19	10

## 6560

КРАН С ЦАНГОВЫМ СОЕДИНЕНИЕМ (СТАНДАРТНАЯ РУЧКА - КРАСНАЯ НАКЛАДКА)  
 WITH PUSH-IN CONNECTIONS VALVE (STANDARD HANDLE - RED PLATE)

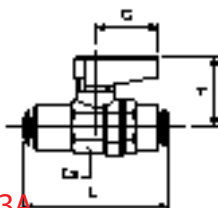

НЕ ДЛЯ ГАЗА

Код Code	Трубка Tube	Тубка Tube	DN	ES	L	G	H	Упак. Pack.
065600001	4	4	3	14-15	44	19	21	10
065600002	6	6	5	14-15	48	19	21	10
065600003	8	8	5.5	14-15	48	19	21	10
0656000075	10	10	8	18-19	58.5	19	22	10
0656000076	12	12	10	22-23	66	26	30.5	10

## 6570

КРАН КОНИЧЕСКАЯ R ISO 7 - ЦАНГОВОЕ СОЕДИНЕНИЕ (СТАНДАРТНАЯ РУЧКА - КРАСНАЯ НАКЛАДКА)  
 TAPER MALE R ISO 7 - PUSH-FIT CONNECTIONS VALVE (STANDARD HANDLE - RED PLATE)

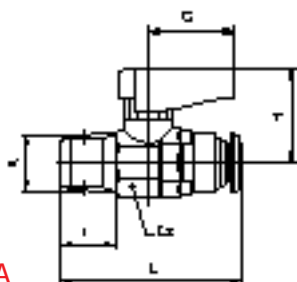

НЕ ДЛЯ ГАЗА

Код Code	A	Трубка Tube	F	Es	L	C	H	Упак. Pack.
0657000001	1/8	4	8.5	14-15	35	19	21	10
0657000002	1/8	6	8.5	14-15	40	19	21	10
0657000004	1/8	8	8.5	14-15	41.5	19	21	10
0657000003	1/4	6	12.5	14-15	38.5	19	21	10
0657000005	1/4	8	12.5	14-15	45.5	19	22	10

## 6600

КРАН ВЫПУСКНОЙ G ISO 228 (СТАНДАРТНАЯ РУЧКА - КРАСНАЯ НАКЛАДКА)  
 EXHAUST HOLE FEMALE G ISO 228 - FEMALE G ISO 228 VALVE (STANDARD HANDLE - RED PLATE)



НЕ ДЛЯ ГАЗА

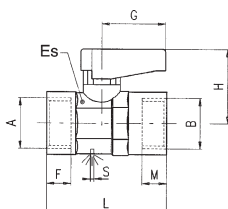

Код Code	A	B	DN	ES	F	M	L	G	H	S	Упак. Pack.
0660000001	1/8	1/8	5.5	14-15	7	7	35	19	21	2.5	10
0660000002	1/4	1/4	5.5	14-15	8	8	37	19	21	2.5	10
0660000003	3/8	3/8	8	18-19	9	9	42	19	22	3	10

# 6700

КРАН - ТРОЙНИК G ISO 228 (СТАНДАРТНАЯ РУЧКА - КРАСНАЯ НАКЛАДКА)  
3 WAYS FEMALE G ISO 228 VALVE (STANDARD HANDLE - RED PLATE)



НЕ ДЛЯ ГАЗА

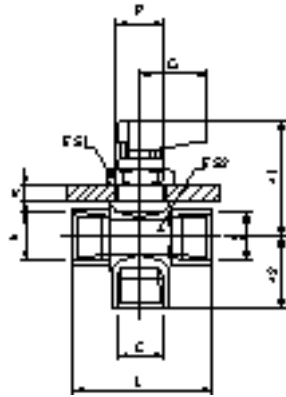

Код Code	A	B	C	DN	ES1	ES2	L	G	H1	H2	SMax	P	Упак. Pack.
0670000001	1/8-1/8-1/8			5	17	17	35	19	33.5	15.5	4.5	14.5	25
0670000002	1/4-1/4-1/4			5	17	17	37	19	33.5	17.5	4.5	14.5	25
0670000003	3/8-3/8-3/8			7	17	21	42	19	35	19.5	4.5	14.5	10

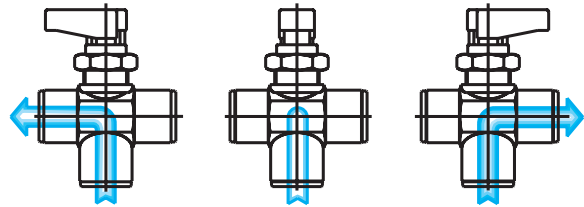

# 6710

КРАН - ТРОЙНИК G ISO 228 (СТАНДАРТНАЯ РУЧКА - КРАСНАЯ НАКЛАДКА)  
3 WAYS FEMALE G ISO 228 VALVE (STANDARD HANDLE - RED PLATE)



НЕ ДЛЯ ГАЗА

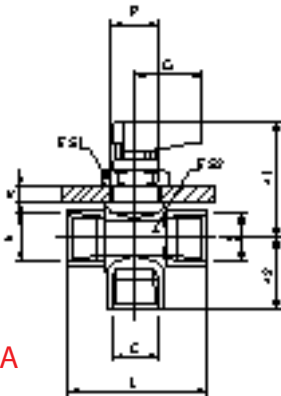

Код Code	A	B	C	DN	ES1	ES2	L	G	H1	H2	SMax	P	Упак. Pack.
0671000001	1/8-1/8-1/8			5	17	17	35	19	33.5	15.5	4.5	14.5	25
0671000002	1/4-1/4-1/4			5	17	17	37	19	33.5	17.5	4.5	14.5	25
0671000003	3/8-3/8-3/8			7	17	21	42	19	35	19.5	4.5	14.5	10

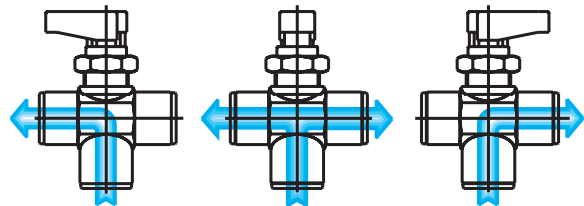

# 6720

КРАН УГЛОВОЙ G ISO 228 (СТАНДАРТНАЯ РУЧКА - КРАСНАЯ НАКЛАДКА)  
"L" VALVE FEMALE G ISO 228 VALVE (STANDARD HANDLE - RED PLATE)



НЕ ДЛЯ ГАЗА

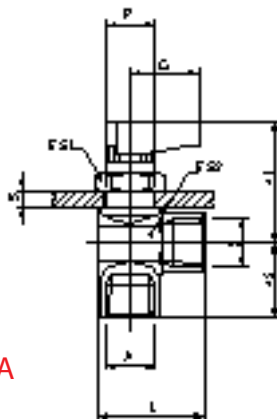

Код Code	A	B	DN	ES1	ES2	L	G	H1	H2	SMax	P	Упак. Pack.
0672000001	1/8 -1/8		5	17	17	28.5	19	33.5	15.5	4.5	14.5	25
0672000002	1/4 -1/4		5	17	17	28.5	19	33.5	17.5	4.5	14.5	25
0672000003	3/8 -3/8		7	17	21	31	19	35	19.5	4.5	14.5	10

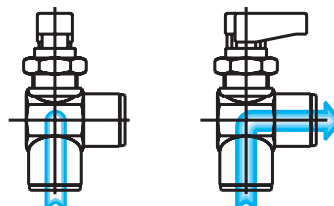

## 6900

РУЧКА СТАНДАРТНАЯ - STANDARD HANDLE

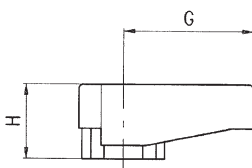

Код Code	Тип Type	G	H	Упак. Pack.
06900A0300000	A	19	11	25
06900B0300000	B	26	15	25

 A = для кранов 1/8, 1/4, 3/8.  
 A = For valves of 1/8, 1/4, 3/8.

 B = для кранов 1/2, 3/4.  
 B = For valves of 1/2, 3/4.

## 6910

РУЧКА УДЛИНЕННАЯ - LONG HANDLE

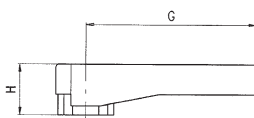

Код Code	Тип Type	G	H	Упак. Pack.
06910A0300000	A	35	11	25
06910B0300000	B	50	15	25

 A = для кранов 1/8, 1/4, 3/8.  
 A = For valves of 1/8, 1/4, 3/8.

 B = для кранов 1/2, 3/4.  
 B = For valves of 1/2, 3/4.

## Удлинение штока/ Spindle Extension

Все краны серии "GHILUX" могут быть поставлены с удлинением штока (см. рис.) Для заказа следуйте инструкции указанной выше "КАК ЗАКАЗАТЬ".

All the valves "GHILUX" can be supplied with a spindle extension (see the picture). To order use the same instructions mentioned in the previous page "HOW TO ORDER".

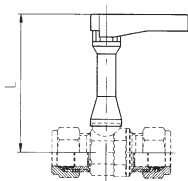

## 6915

 УДЛИНЕНИЕ ШТОКА (с удлиненной ручкой и винтом)  
 SPINDLE EXTENSION (WITH LONG HANDLE, SCREW)

Код Code	Тип Type	Размер крана Valve size	L	Упак. Pack.
0691500001	A	1/8	58	10
		1/4	58	
		3/8	59	
0691500002	B	1/2	68	10
		3/4	70	

## 6920

 ЦВЕТНЫЕ НАКЛАДКИ  
 COLOURED PLATE



Код Code	Тип Type	Цвет Colors	Упак. Pack.
06920A03000RO	A	ROSSO / RED	100
06920B03000RO	B	ROSSO / RED	100
06920A03000GI	A	*GIALLO / YELLOW	100
06920B03000GI	B	*GIALLO / YELLOW	100
06920A03000BL	A	BLU / BLUE	100
06920B03000BL	B	BLU / BLUE	100
06920A03000VE	A	VERDE / GREEN	100
06920B03000VE	B	VERDE / GREEN	100
06920A03000BN	A	BIANCO / WHITE	100
06920B03000BN	B	BIANCO / WHITE	100

 \*ЖЕЛТАЯ накладка с маркировкой EN 331 для применения с газом  
 \*YELLOW Plate with marking EN 331 For use with gas

 A = для клапанов 1/8, 1/4, 3/8. B = для клапанов 1/2, 3/4.  
 A = For valves of 1/8, 1/4, 3/8. B = For valves of 1/2, 3/4.

# 6680

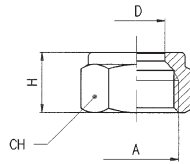
ГАЙКА - NUT



Код Code	D	A	H	CH	Упак. Pack.
066800001BSCT	6	1/8	11	12	100
066800001BJCT	8	1/4	12	15	100
066800001CGCT	10	3/8	13	19	100
066800001CLCT	12	3/8	14	19	100
066800001DBCT	14	1/2	15	24	100
066800001CPCT	15	1/2	15	24	100
066800001CSCT	16	3/4	17	30	100
066800001CXCT	18	3/4	17	30	100

# 10740

ЛАТУННОЕ ВРЕЗНОЕ КОЛЬЦО - BRASS OLIVE

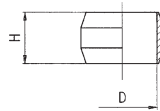

Код Code	D	H	Упак. Pack.
107400002X400	6	6.5	50
107400002X700	8	6.5	50
107400002X900	10	7.5	50
107400002Y100	12	8	50
107400002Y400	15	9	25
107400002Y700	18	10	25

# 10741

АТУННОЕ ВРЕЗНОЕ КОЛЬЦО - BRASS OLIVE

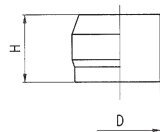

Код Code	D	H	Упак. Pack.
107410001Y300	14	12	50
107410001Y500	16	13.5	50

# 10760

ВРЕЗНОЕ КОЛЬЦО ИЗ PTFE - PTFE OLIVE

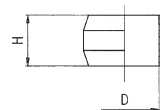

Код Code	D	H	Упак. Pack.
107600028X400	6	6.5	50
107600028X700	8	6.5	50
107600028X900	10	7.5	50
107600028Y100	12	8	50
107600028Y400	15	9	50
107600028Y700	18	10	50

# 10761

ВРЕЗНОЕ КОЛЬЦО ИЗ PTFE - PTFE OLIVE

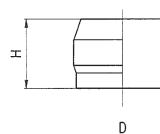

Код Code	D	H	Упак. Pack.
107610028Y300	14	12	50
107610028Y500	16	13.5	50

## Шаровые краны МИНИ / Mini Ball Valves

Шаровые краны МИНИ Art. 6065 и Art. 6066 это запорные краны. Открытие и закрытие кранов осуществляется в ручную поворотом штока рукой или гаечным ключем.

The mini ball valves Art. 6065 and Art. 6066 are shutoff valves type ON-OFF. The opening and closing functions are made by hand, acting on the control spindle of the ball with the handle, or operated with a spanner.

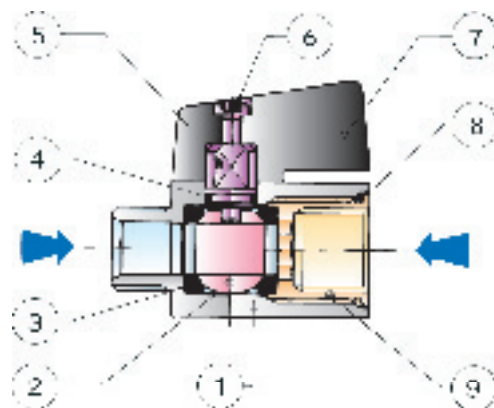

### Части и материалы / Component Parts and Materials

1 Никелированный латунный корпус	1 Nickel-plated Brass Body
2 Никелированный латунный шар	2 Nickel-plated Brass Ball
3 Уплотнение из PTFE	3 PTFE Seats
4 Уплотнительное кольцо из NBR 70	4 NBR 70 Seal O-RING
5 Никелированный латунный шток	5 Nickel-plated Brass Spindle
6 Стальной винт	6 Steel Screw
7 Рукоятка из РА66 армированная стекловолокном	7 PA66 Glass reinforced Handle
8 Уплотнительное кольцо из NBR 70	8 NBR 70 Seal O-RING
9 Никелированный латунный фитинг	9 Nickel-plated Brass Fitting

### Давление / Pressures

Минимальное давление / Minimum Pressure: -0.99 bar (-0.099MPa)  
 Максимальное давление / Maximum pressure: 10 bar (1 MPa)

### Резьбы / Threads

Цилиндрическая ISO 228 Classe A  
 Parallel gas in conformity with ISO 228 Class A.

### Соединяемые трубки / Connection Tubes

Металлические трубки и различные виды фитингов.

Tubes made in metal in general and various fittings.

### Температура / Temperatures

Минимальная температура / Minimum temperature: -15 °C  
 Максимальная температура / Maximum temperature: +110 °C

**С водой / With Water**

Минимальная температура / Minimum temperature: 0 °C  
 Максимальная температура / Maximum temperature: +90 °C

### Рабочая среда / Fluids

Сжатый воздух, вода,  
 масло.  
 Вакуум.  
 Compressed air, water,  
 various types of oils, etc.  
 Vacuum.

## 6065

КРАН ШАРОВЫЙ МИНИ G ISO 228 - G ISO 228 - MINI BALL VALVE FEMALE G ISO 228 - FEMALE G ISO 228



NO GAS

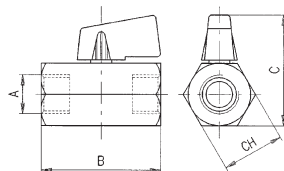

код Code	A	DN	B	C	CH	Упак. Pack.
0606500001	1/8	6	39	38	21	10
0606500002	1/4	8	40	38	21	10
0606500003	3/8	8	42	38	21	10
0606500004	1/2	10	48	42	25	10
0606500005	3/4	12	54	47	30	10

## 6066

КРАН ШАРОВЫЙ МИНИ G ISO 228 - G ISO 228 - MINI BALL VALVE MALE GA ISO 228 - FEMALE G ISO 228



NO GAS

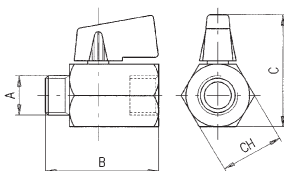

Код Code	A	DN	B	C	CH	Упак. Pack.
0606600001	1/8	6	39	38	21	10
0606600002	1/4	8	39	38	21	10
0606600003	3/8	8	40	38	21	10
0606600004	1/2	10	46	42	25	10
0606600005	3/4	12	51	47	30	10

## Шаровые краны / Ball Valves

Шаровые краны это запорные краны обеспечивающие высокий расход. Открытие и закрытие кранов осуществляется в ручную поворотом штока рукой или гаечным ключем.

The ball valves full port are shutoff valves type ON-OFF, suitable for high flow rate. The opening and closing functions are made by hand, acting on the control spindle of the ball with the handle, or operated with a spanner.

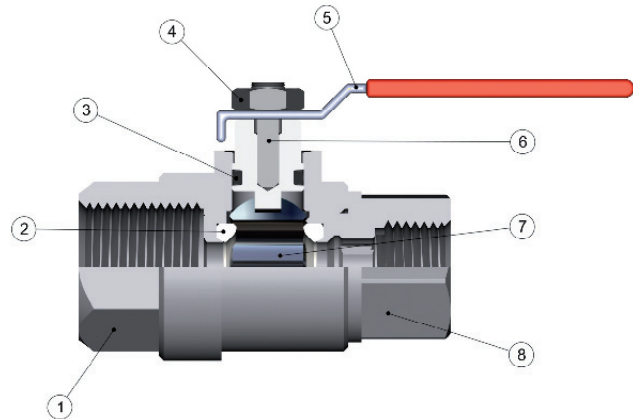

### Части и материалы / Component Parts and Materials

- 1 Никелированный латунный фитинг
- 2 Седло из PTFE
- 3 Уплотнение штока из NBR
- 4 Стальная гайка
- 5 Стальная рукоятка
- 6 Никелированный латунный шток
- 7 Хромированный латунный шар
- 8 Никелированный латунный корпус

- 1 Nickel-plated Brass Fitting
- 2 PTFE Seats
- 3 NBR Stem Seal
- 4 Steel Nut for lever
- 5 Steel plastified Lever handle
- 6 Nickel-plated Brass Stem
- 7 Chrome Nickel-plated Brass Ball
- 8 Nickel-plated Brass Body

### Резьбы / Threads

Art. 6067 / 6069

Цилиндрическая ISO 228 classe A.  
Parallel gas in conformity with ISO 228 class A.

Art. 6068

Gas RP ISO7  
Gas RP ISO7

### Tubi di collegamento / Connection Tubes

Tubi metallici in genere, raccorderia varia.  
Tubes made in metal in general and various fittings.

### \*\* ДИАГРАММА ДАВЛЕНИЕ-ТЕМПЕРАТУРА PRESSURE-TEMPERATURE RATINGS DIAGRAM

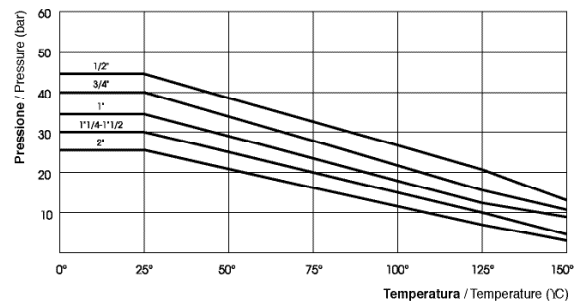

## 6067

КРАН ШАРОВЫЙ G ISO 228 - G ISO 228 - BALL VALVE, FEMALE G ISO 228 - FEMALE G ISO 228

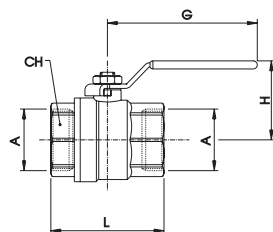
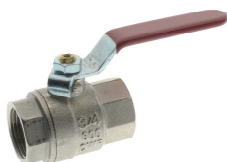

Код Code	A	DN	CH	L	G	H	Упак. Pack.
0606700001	1/2	15	25	46	88	47.5	10
0606700002	3/4	20	31	56.5	88	51	10
0606700003	1"	25	38	65.5	105	63	5
0606700004	1 1/4	32	48	77	105	68.5	2
0606700005	1 1/2	40	54	88.5	134	84.5	1
0606700006	2"	50	67	101.5	134	92.5	1

ART.6067:

Рабочая среда: сжатый воздух, вода, масло.

Для DN 15 и DN20: Используйте данные диаграммы\*\*

Для DN25 до DN50, Максимальное давление: 18 bar

Fluid: Compressed air, water, oil.

DN 15 and 20: Use Diagram condition\*\*

From DN25 to DN50, Max Pressure: 18 bar

## 6068

КРАН ШАРОВЫЙ ГАЗОВЫЙ, RP ISO7 - RP ISO7 - GAS BALL VALVE, FEMALE RP ISO7 - FEMALE RP ISO7

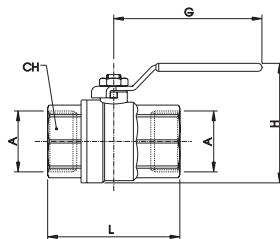

Код Code	A	DN	CH	L	G	H	Упак. Pack.
0606800001	1/2	15	26	59	88	58	10
0606800002	3/4	20	32	67.3	88	65	10
0606800003	1"	25	40	77.5	105	74	5
0606800004	1 1/4	32	49	92	105	85	2
0606800005	1 1/2	40	55	101.5	134	100	1
0606800006	2"	50	68	122.5	134	116.5	1

ART.6068:

 Dal DN15 al DN50: Fluidi: 1° e 2° Famiglia di gas a media pressione e 3° famiglia di gas a bassa pressione. OMOLOGATE EN 331 fino a pressione Max: 5 bar  
 From DN 15 to 50: Fluids: 1<sup>st</sup> and 2<sup>nd</sup> gas family to medium pressure and 3<sup>th</sup> gas family to low pressure OMOLOGATED EN331 to Max pressure: 5bar

## 6069

КРАН ШАРОВЫЙ G ISO 228 - G ISO 228 - BALL VALVE MALE GA ISO 228 - FEMALE G ISO 228

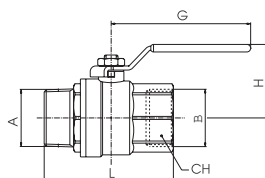
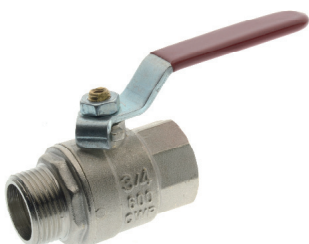

Код Code	A	B	DN	CH	L	G	H	Упак. Pack.
0606900001	1/2	1/2	15	25	56	88	47.5	10
0606900002	3/4	3/4	20	31	63.5	88	51	10
0606900003	1"	1"	25	38	74	105	63	5
0606900004	1 1/4	1 1/4	32	48	85	105	68.5	2
0606900005	1 1/2	1 1/2	40	54	100	134	84.5	1
0606900006	2"	2"	50	67	121.5	134	92.5	1

ART.6069:

Fluidi: Рабочая среда: сжатый воздух, вода, масло.

Для DN 15 и DN20: Используйте данные диаграммы стр. 10.15\*\* Для DN25 до DN50, Максимальное давление: 18 bar

Fluid: Compressed air, water, oil.

DN 15 and 20: Use Diagram condition Pag. 10.15\*\* - From DN25 to DN50, Max Pressure: 18 bar

## Фильтр "Y" / "Y" Filter

### Части и материалы / Component Parts and Materials

Латунный корпус от 1/4 до 2"  
 Бронзовый корпус от 2 1/2 до 4"  
 Латунная крышка  
 Фильтр из стали AISI 304  
 Уплотнение из NBR

Brass body from 1/4 to 2"  
 Bronze body from 2 1/2 to 4"  
 Brass Cap  
 Steel AISI 304 Strainer  
 NBR Body Seal

### Давление / Pressures

Pressioni alle temperature di riferimento :

Pressures to reference temperature:

18 BAR 80°C  
 16 BAR 100°C  
 10 BAR 120°C

### Степень фильтрации / Filtration degree

От 1/4 до 2" 500 µm; от 2 1/2, 3" до 4" 800 µm.

From 1/4 to 2" 500 µm; 2 1/2, 3" e 4" 800 µm.

### Рабочая среда / Fluids

Вода, масло.

Water, Oil.

### Рабочая температура Working temperature

От -20°C до +110°C без пара.

From -20°C to +110°C without steam.

## 6035

FILTRO "Y" PN 20 - "Y" FILTER PN 20

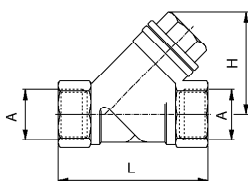

Код Code	A	DN	L	H	Упак. Pack.
0603500001	1/4	8	55	40	10
0603500002	3/8	10	55	40	10
0603500003	1/2	15	58	40	10
0603500004	3/4	20	70	50	10
0603500005	1"	25	87	56	5
0603500006	1 1/4	32	96	64	2
0603500007	1 1/2	40	106	73	2
0603500008	2"	50	126	89	1
0603500009	2 1/2"	65	150	107	1
0603500010	3"	80	170	120	1
0603500011	4"	100	219	161	1



## Обратный клапан / No return Valve

### Технические характеристики / Technical Characteristics

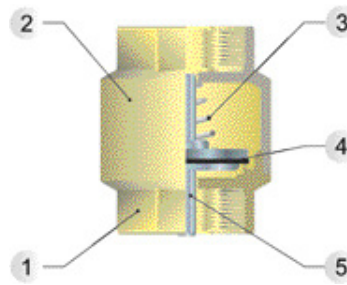

### Части и материалы / Component Parts and Materials

- |                                |                          |
|--------------------------------|--------------------------|
| 1 Латунный корпус              | 1 Brass Body             |
| 2 Латунная крышка              | 2 Brass Cover Cap        |
| 3 Пружина из нержавеющей стали | 3 Stainless steel Spring |
| 4 Уплотнение из NBR 65 SH/PS   | 4 NBR 65 SH/PS Seal      |
| 5 Пластиковый клапан           | 5 Plastic Shutter        |

### Давление / Pressures

Минимальное давление / Minimum pressure: -0.99 bar (-0.099 MPa)  
 Максимальное давление / Maximum pressure: 15 bar (1.5 MPa)

### Температура / Temperatures

Минимальная температура / Minimum temperature: 0 °C  
 Максимальная температура / Maximum temperature: +90 °C

### Fluidi compatibili / Fluids

Acqua, Aria compressa, Oli.  
 Water, Compressed Air, Oil.

## 6036

ОБРАТНЫЙ КЛАПАН - NON RETURN VALVE

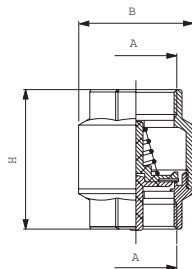

Код Code	A	H	B	Упак. Pack.
0603600001	1/2	49	34.5	10
0603600002	3/4	53.5	42.5	5
0603600003	1"	58.5	47.5	5
0603600004	1"1/4	66.5	60	2
0603600005	1"1/2	72	69	2
0603600006	2"	77	85	1

## 6037

ОБРАТНЫЙ КЛАПАН - FINAL VALVE

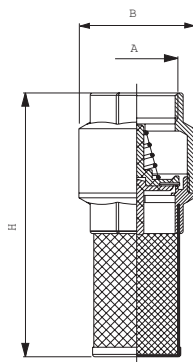

Codice Code	A	H	B	Conf. Pack.
0603700001	1/2	91	34.5	10
0603700002	3/4	100.5	42.5	5
0603700003	1"	105	47.5	5
0603700004	1"1/4	125	60	4
0603700005	1"1/2	140	69	2
0603700006	2"	160	85	1

## 6038

ФИЛЬТР - STRETCHED NET-FILTER

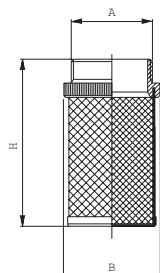

Codice Code	A	B	H	Conf. Pack.
0603800002	1/2	26	50	10
0603800003	3/4	32	57	5
0603800004	1"	41	56.5	5
0603800005	1"1/4	49	69.5	5
0603800006	1"1/2	55	79	5
0603800007	2"	68	95	1

